



DIE CAST
MACHINERY
LLC

(847) 360-9170

World Leader in Used Die Casting Machinery!

HOME

RECENT
ADDITIONS

INDUSTRY
SERVICES

JOIN OUR
MAILING LIST

SELL US
YOUR MACHINE

If we can be of any assistance or if you have any questions,
please don't hesitate to contact us at (847) 360-9170.

You may also visit our website at
<https://www.diecastmachinery.com>

Thank you!

REGAL

OIL TEMPERATURE CONTROLLER

TM

"RK" Series



with
**Regal 1 LE
Instrument**

I.O.M. #021 11/96

INSTRUCTION MANUAL

- INSTALLATION
- OPERATION
- MAINTENANCE



ADVANTAGE ENGINEERING, INC.
525 East Stop 18 Road
Greenwood, IN 46142
317-887-0729 fax: 317-881-1277
Service Department fax: 317-885-8683

REGAL

OIL TEMPERATURE CONTROLLER

TM

"RK" Series

INSTRUCTION MANUAL
REGAL 'RK'
500°F HOT OIL TEMPERATURE CONTROLLER
HEATING AND COOLING MODELS
REGAL 1 LE INSTRUMENT

COVERING

INSTALLATION
OPERATION
MAINTENANCE



ADVANTAGE ENGINEERING, INC.

525 East Stop 18 Road

Greenwood, IN 46142

317-887-0729 fax: 317-881-1277

Service Department fax: 317-885-8683

Web site: <http://www.advantageengineering.com>

Email: sales@advantageengineering.com

TABLE OF CONTENTS

1.0	GENERAL	7
	1.1 Safety	8
	1.2 Efficiency	8
	1.3 Component placement	9
2.0	INSTALLATION	11
	2.1 General	12
	2.2 To and from process connections	12
	2.3 Water supply connection	12
	2.4 Drain connection	14
	2.5 Electrical connection	15
3.0	OPERATIONS	17
	3.1 General	18
	3.2 Start up/operations procedure	18
	3.3 Regal 1 LE instrument operation	23
	3.4 Shut down/disconnect procedure	28
	3.5 Mold purge procedure	30
4.0	TROUBLESHOOTING	31
	4.1 Unit will not start ("power" light off)	32
	4.2 Unit will not start ("power" light on)	32
	4.3 Unit stops	33
	4.4 Unit overheats	33
	4.5 Unit underheats	35
5.0	MAINTENANCE	37
	5.1 Preventive maintenance	38
	5.2 Pump seal service	39
	5.3 Heating cylinder service	43
	5.4 Solenoid valve service	45
	5.5 Configuring temperature display units	47
	5.6 Configuring alarm temperature parameter	48
6.0	REGAL COMPONENTS	49
	6.1 Mechanical system	50
	6.2 Electrical system	53
7.0	RELATED DRAWINGS	55
	7.1 Regal 'RK' physical - 6-27 KW heaters & 1-3 HP pumps	56
	7.2 Regal 'RK' physical - 18/48 KW 27-36 KW heaters & 1-3 HP pumps	57
	7.3 Regal 'RK' circuit schematic	58
	7.4 Regal 'RK' electrical - Regal 1 LE instrument	59



8.0	APPENDIX	61
8.1	Regal 'RK' specifications	62
8.2	Regal 'RK' model # and suffix coding	63
8.3	Regal water cooled process pumps	64
8.4	AMP ratings for three phase motors	65
8.5	AMP ratings for single and three phase heaters	66
8.6	Specific heat and density for common materials	67
8.7	Useful engineering formulas	68
8.8	Regal 'RK' spare parts list - 460 volt	69
8.9	Regal 'RK' spare parts list - 230 volt	70
8.10	Paratherm NF Specifications	71



THIS PAGE INTENTIONALLY BLANK

1.0 GENERAL

- 1.1 SAFETY**
- 1.2 EFFICIENCY**
- 1.3 COMPONENT PLACEMENT**



1.1 SAFETY

- A. It is important to become thoroughly familiar with this manual and the operating characteristic of the equipment.
- B. Several important references are made to safety considerations in this manual. It is the owner's responsibility to assure proper operator training, installation, operation, and maintenance of the **REGAL 'RK'** temperature controller with **Regal 1 LE** instrument.

1.2 EFFICIENCY

- A. Long term efficiency of operation is largely determined by proper maintenance of the mechanical parts of the unit and the oil quality. **ADVANTAGE** accepts no responsibility for inefficient operation or damage caused by improper installation or foreign materials in the process fluid.

This warning label is attached to the lift off panel.



1.3 COMPONENT PLACEMENT

- A. The **ADVANTAGE Regal 'RK'** temperature controller with **Regal 1 LE** instrument is designed to circulate temperature stabilized fluid through the process resulting in process temperature control.
- B. The ability of the equipment to do this is significantly affected by the method of installation.
- C. If any questions arise, please contact your **ADVANTAGE** Sales Representative or the **ADVANTAGE** Service Department at 317-887-0729.

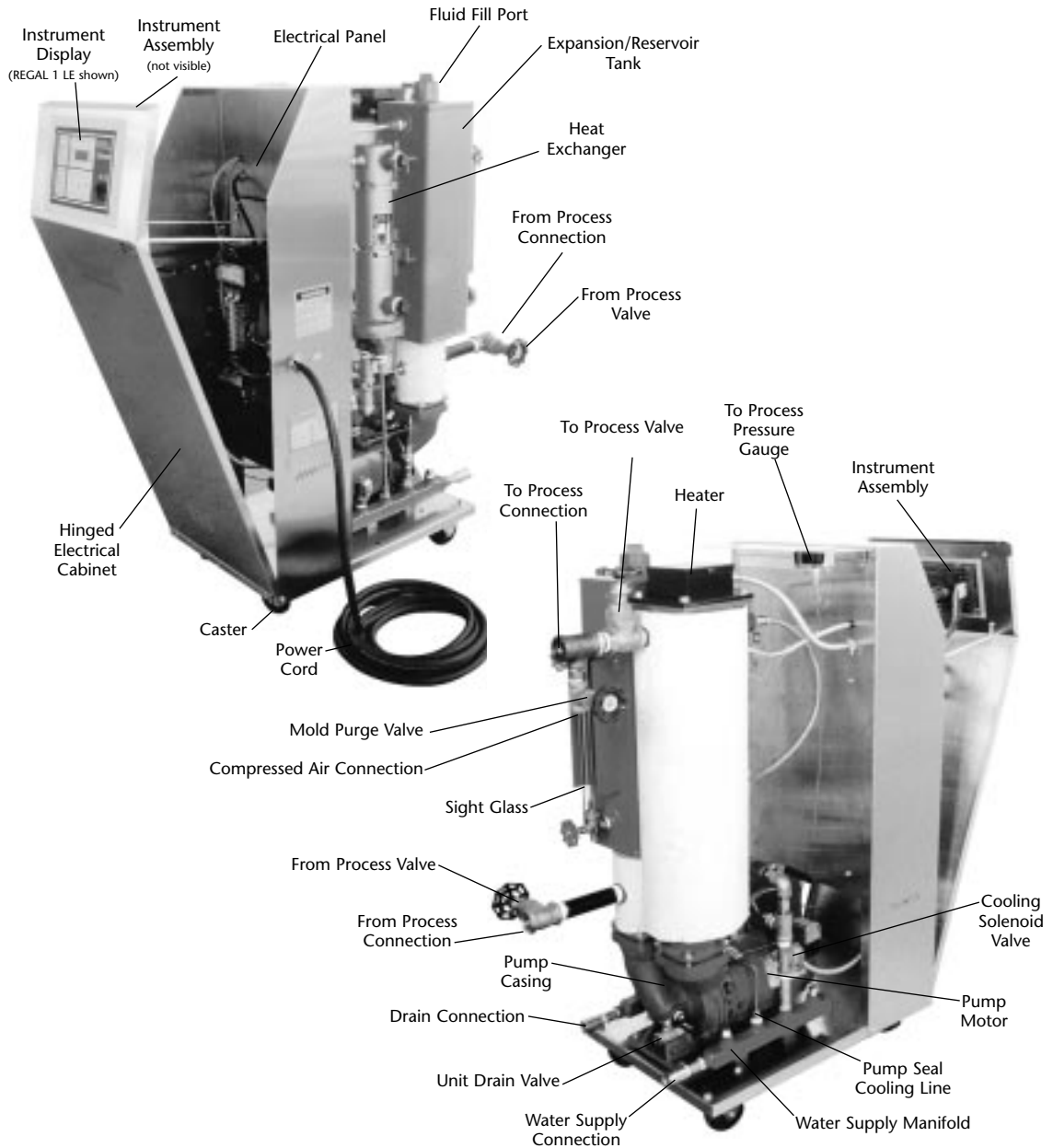

THIS PAGE INTENTIONALLY BLANK

2.0 INSTALLATION

- 2.1 GENERAL**
- 2.2 TO AND FROM PROCESS CONNECTIONS**
- 2.3 WATER SUPPLY CONNECTION**
- 2.4 DRAIN CONNECTION**
- 2.5 ELECTRICAL CONNECTION**



2.1 GENERAL

- A. All process piping materials (such as hose, rigid piping, valves or filters) used in process water piping circuitry must be rated for 600°F minimum temperature and 75 PSI minimum pressure.
- B. All such materials must have the equivalent or larger diameter of the particular process connection that length of process water piping is connected to.

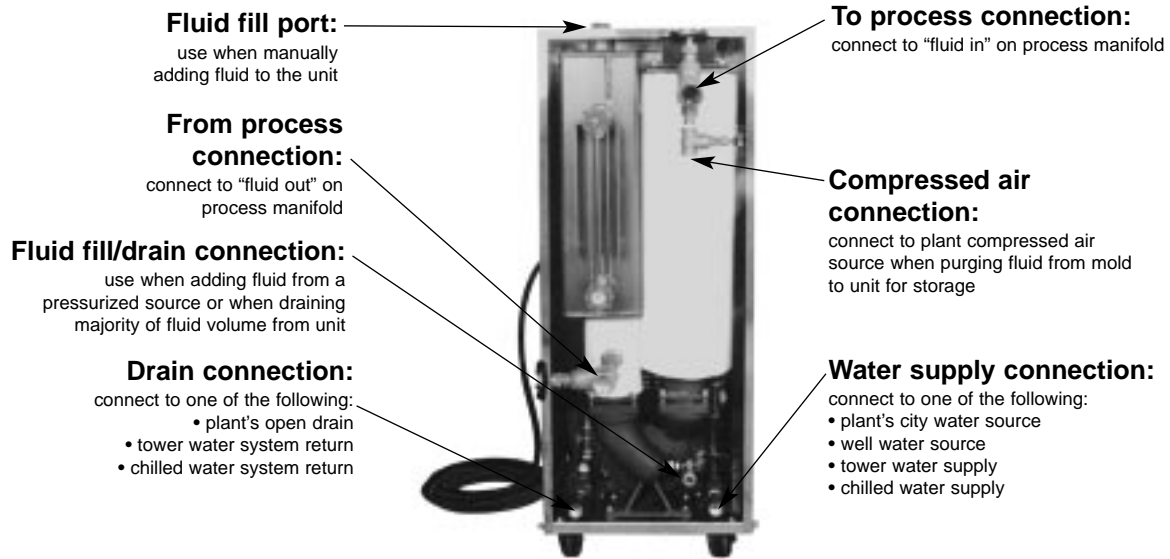

2.2 TO AND FROM PROCESS CONNECTIONS

- A. Connect the unit's '**TO PROCESS**' port to the 'fluid in' port on the process manifold.
- B. Connect the unit's '**FROM PROCESS**' port to the 'fluid out' port on the process manifold.
- C. Process circuitry should be designed to avoid an excessive use of elbows and/or lengths of pipe or hose. If hose is the material of choice, teflon lined steel braided hose is recommended for use. If hose is used, avoid tight twists or curls in the process circuitry.

2.3 WATER SUPPLY CONNECTION

- A. Connect the unit's '**WATER SUPPLY**' port to the plant's city water supply, well water supply, tower water system supply or chilled water system supply as required.

- B. Water supply must be a minimum of 1/2 GPM at a maximum temperature of 100°F for efficient component cooling.
- C. The factory recommend minimum operating water supply pressure requirement is identified on the unit's data pate. To protect the unit from operating without adequate supply water, a water pressure switch (figure 2.3A - panel mount switch shown) is plumbed into the supply manifold. If the supply pressure is not sufficient, the pressure switch will stop or prevent unit operations.
- D. On all Regal 'RK' units, cooling water circulates to the supply manifold (figure 2.3B), through the pump adapter cooling jacket, and is then rejected to the drain manifold. This action maintains proper pump seal cavity temperatures.

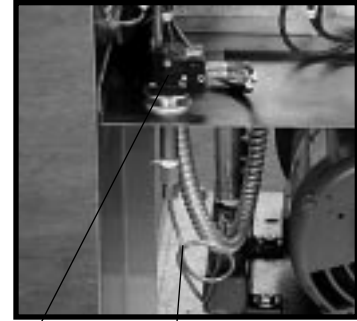

Pressure switch Capillary from manifold Figure 2.3A

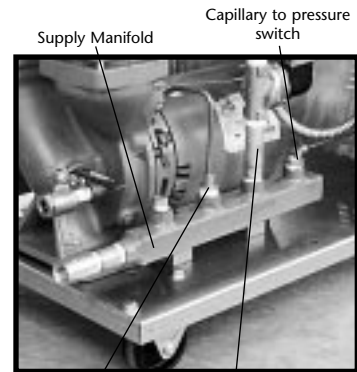

Supply Manifold Capillary to pressure switch Pump seal cooling line Figure 2.3B Water feed to heat exchanger

- E. On Regal 'RK' units with the installed cooling option, a tube and shell heat exchanger (figure 2.3C) for process fluid cooling is supplied and mounted to the expansion tank.
 - 1. The purpose of the heat exchanger is to cool the process fluid. Cooling water from plant water supply circulates through the "tube" side of the heat exchanger. The process fluid circulates through the "shell" side. Cooling water flow is controlled by the solenoid valve.
 - 2. A 1/2" ball valve is placed in the heat exchanger water supply line after the solenoid valve (figure 2.3D). The ball valve should be open during

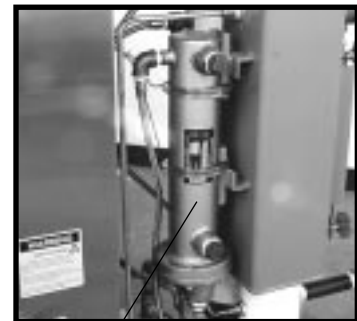

Typical heat exchanger Figure 2.3C

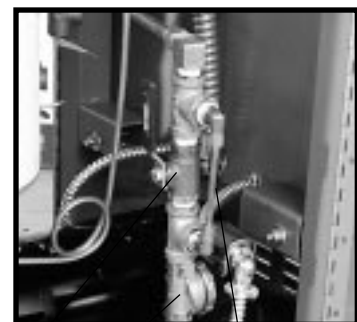

Ball Valve Solenoid valve Capillary tube Figure 2.3D

operations from 100°F to 200°F. During operations with temperatures over 200°F, this valve should be closed. In such cases, the necessary cooling water is proportioned to the heat exchanger through the small capillary line, which some water “steams off” to cool the process fluid. The steam and water mixture is then rejected to drain.

2.4 DRAIN CONNECTION:

- A. Connect the unit's '**DRAIN**' port to one of the following as determined by the water supply source:
1. Plant's open drain for well or city water supply
 2. Tower water system return for tower system water supply
 3. Chilled water system return for chilled water system supply

- B. The 'drain' manifold (figure 2.4A) serves as a collection point for the heat exchanger drain line (if installed) and the pump seal cooling drain line. In most cases, a pressure relief valve is plumbed into the drain manifold.

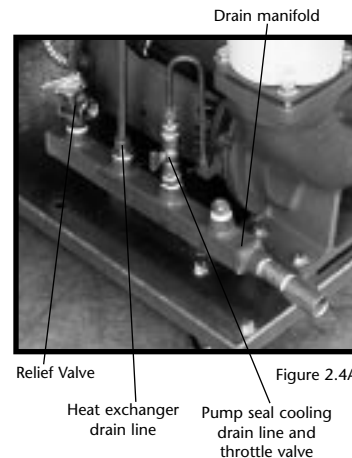

- C. The 'drain' connection should be made of galvanized iron pipe or teflon lined steel braided flexible hose, since steam may be present in the drain line during operations. Rubber hose is not recommended.
- D. The factory recommends that the water supply and drain line pressure differential should be a minimum of 10 psi to ensure proper cooling.
- E. For most applications, the drain line should not be valved. However, for installations with a pressurized drain system, it may be necessary to install a valve in the drain line. In such cases, the installed valve must be fully opened after installation and the valve handle removed. This prevents operating the unit with a closed drain valve. The valve handle can be reattached to the valve body when it is necessary to close the valve.
- F. **CAUTION:** the unit must never be operated with a closed drain line valve. A closed drain line valve prevents adequate system cooling and will lead to the unit overheating. Overheating of the mold temperature controller may lead to unit damage or serious personal injury.

2.5 ELECTRICAL CONNECTION

A. NEMA 1 MODELS (no "J" in model number suffix)

1. Electrical power supply requirements for Nema 1 units (figure 2.5A) are identified on the equipment data plate. **VERIFY THAT THE AVAILABLE VOLTAGE SUPPLY IS THE SAME AS THE UNIT'S VOLTAGE REQUIREMENTS.** **WARNING:** Do not connect the unit to a voltage supply source not equal to the unit's voltage requirements as specified on the unit's data plate. Use of incorrect voltage will void the unit's warranty and cause a significant hazard that may result in serious personal injury and unit damage.

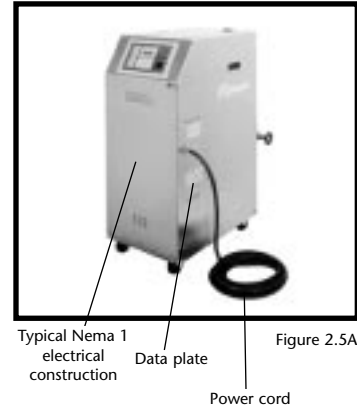

2. A four conductor cable, 10 foot in length, has been provided for connection to a fused disconnecting means. The owner supplied fused disconnecting means shall be sized and installed according to the unit's power supply requirements and local electrical codes.

B. NEMA 12 MODELS ("J" in model number suffix)

1. NEMA 12 units are constructed (figure 2.5B) with a dust tight electrical enclosure and branch circuit fusing. Electrical power supply requirements are identified on the equipment data plate. **VERIFY THAT THE AVAILABLE VOLTAGE SUPPLY IS THE SAME AS THE UNIT'S VOLTAGE REQUIREMENTS.** **WARNING:** Do not connect the unit to a voltage supply source not equal to the unit's voltage requirements as specified on the unit's data plate. Use of incorrect voltage will void the unit's warranty and cause a significant hazard that may result in serious personal injury and unit damage.

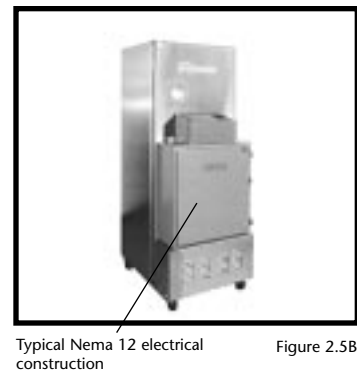

2. Appropriate conduit and fittings should be selected which will maintain the integrity of the cabinet.

3. Supply a power conductor sized according to the unit's power supply requirements. Connect the power conductor to the unit's power supply entry terminal block on the fused disconnect switch.

C. CONTROL CIRCUIT WIRING

1. The unit's supplied control circuit is 110 volt, 1 phase, 60 cycle. The control circuit is supplied by the factory installed transformer. A control circuit fuse is located on the transformer chassis.
2. All unit safety and operational control circuits are interlocked and will not operate unless the pump is on.

D. GENERAL

1. Make certain all ground connections to the unit are properly affixed.
2. Make certain power conductor, disconnecting means, and fusing are properly sized according to the unit's power supply requirements.
3. Make certain all electrical connections are tightly affixed. Any loose wiring connections must be tighten before engaging the power supply.
4. Make certain no moisture or standing water is present inside the electrical cabinet.

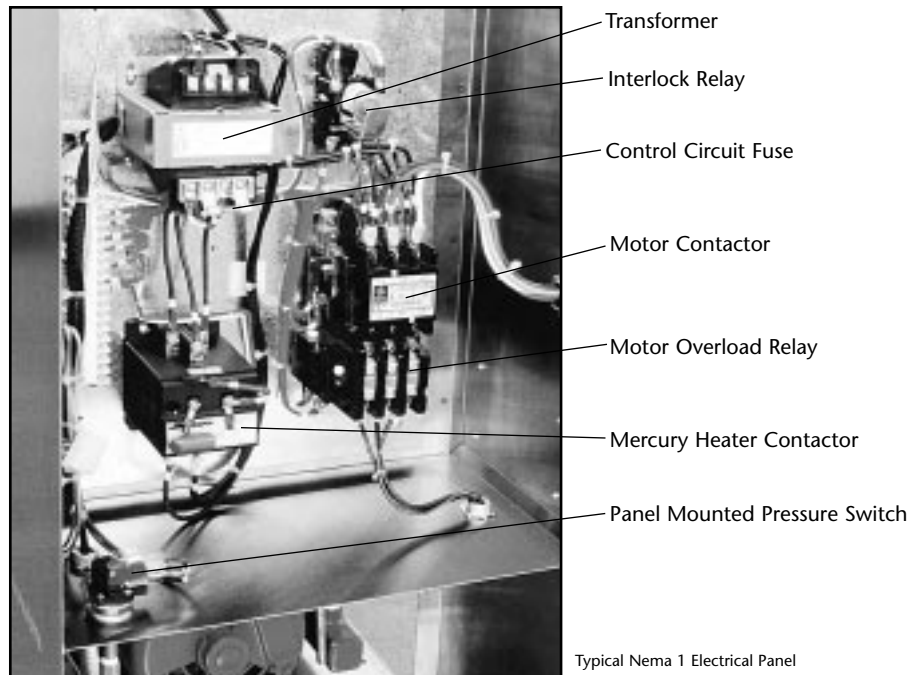

Typical Nema 1 Electrical Panel

3.0 OPERATIONS

- 3.1 GENERAL**
- 3.2 START UP/OPERATIONS PROCEDURE**
- 3.3 REGAL 1 LE INSTRUMENT OPERATION**
- 3.4 SHUT DOWN/DISCONNECT PROCEDURE**
- 3.5 MOLD PURGE PROCEDURE**



3.1 GENERAL

- A. Failure to follow the factory required operation procedures may adversely affect the unit's ability to adequately control process temperature and may create a hazardous operating condition which may result in unit damage and serious operator injury.
- B. The operator must verify that all plumbing and electrical connections are in accordance to section 2 of this manual and local codes.
- C. The Operations segment of this manual is outlined below:

3.2 Start-up/operations procedure - follow this segment to start the unit after the initial installation or to restart the unit after reinstallation to the same or different process system. This section includes information on system fill, electric motor phasing (pump rotation) and process flow adjustments.

3.3 Regal 1 LE instrument - follow this segment to start up and operate the **Regal 1** instrument. This section includes information on setpoint selection and adjustment, and feature explanations.

3.4 Shut down procedure - follow this segment to shut down the unit. This segment includes information on system cool down, shut down, electrical power supply precautions, and disconnection from system.

3.5 Mold purge operation - follow this segment to purge the process fluid into the unit when changing molds.

3.2 START UP/OPERATIONS PROCEDURE

A. SYSTEM FILL

1. The primary method of **Regal 'RK'** system fill is through the fill port located on the top of the unit (figure 3.2A). Simply remove the cap plug and add fluid. Replace the cap plug and tighten when the fill is complete.
2. The alternate method of **Regal 'RK'** system fill is through the fill/drain valve. If a pressurized source is available, simply connect to the fill/drain valve, open the valve and engage the supply source. Close the

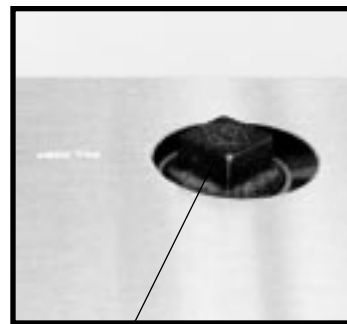

Fill port and cap plug

Figure 3.2A

valve when the fill is complete.

3. Proper unit fill is essential for efficient and safe operation. An oil level sight glass is provided to determine unit fill (figure 3.2B). For initial fill: units up to 12 KW - fill until the sight glass is 1/2 full; for units up from 27 to 48 KW fill until the sight glass is completely full. When the pump is first started, the oil level will drop as the heater tank and process are filled. After which, the operator may need to top off as necessary to maintain oil level near the bottom of the sight glass. Check the system for any leaks and repair if necessary.

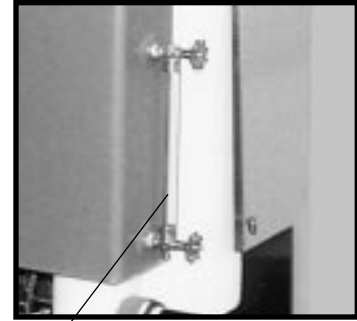

Sight glass

Figure 3.2B

B. ELECTRIC MOTOR PHASING (PUMP ROTATION)

1. The operator must determine the electric motor is phased correctly. This is done by visually inspecting the rotation of the motor shaft and is outlined below. Incorrect phasing of the unit will result in poor operation and eventual damage to the unit.
 - a. Supply electrical power to the unit by engaging the unit's disconnect switch. Once the correct voltage is supplied to the unit, the POWER light on the display will illuminate.
 - b. Access the pump motor by removing or opening the necessary panels. **Note that the electrical power is engaged at this point and caution must be observed while the electrical supply is engaged and cabinet panels are open.**
 - c. Locate the electric motor (figure 3.2C). The operator must identify the motor shaft inside the electric motor housing. The motor shaft can be seen through the vent slots in the motor housing or by removing the shaft cover.

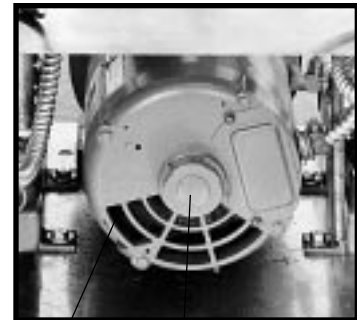

Vent slots

Shaft cover

Figure 3.2C

- d. To start the pump motor, toggle on the UNIT ON/OFF rocker switch, then toggle the PUMP START switch. To stop the pump motor, toggle off the UNIT ON/OFF rocker switch.

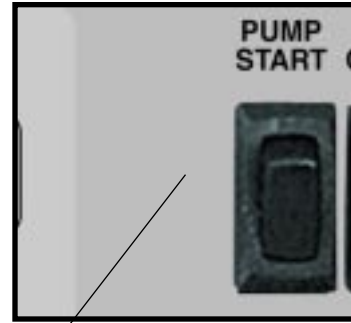

Pump start rocker switch

Figure 3.2D

- e. When the pump is started, observe the motor shaft. When the UNIT ON/OFF switch is turned "off", the motor shaft will slowly "coast" to a stop. As the motor shaft slows to a stop, the operator can identify the rotation of the motor shaft. Correct rotation (correct phase) is "clockwise", when viewed from the rear of the motor. Incorrect rotation is "counter-clockwise" (incorrect phase) when viewed from the rear of the motor.

- f. If the motor shaft is determined to be phased correctly (shaft turns in a clockwise direction), continue with the start up procedure at **step 3**. If the motor shaft is determined to be phased incorrectly (shaft turns in a counter-clockwise direction), continue with start-up procedure at **step 2**.

2. If the motor shaft is phased **incorrectly** (motor shaft turns in a counter clockwise direction), the operator must:
- a. Disengage the electrical power supply to the unit at the disconnect switch. Follow proper lockout procedures before proceeding.
 - b. Once the electrical power supply is disengaged, reverse any two power leads of the power cord at the disconnect terminals.
 - c. **Note:** reversing any two power leads of the power cord will correctly phase an incorrectly phased power supply. **The operator must reverse the power leads at the disconnect switch only and not at the power entry terminals on the unit's electrical panel.** The unit's on-board internal electrical system wiring is phased correctly at the factory and must not be altered in the field.
 - d. Visually inspect motor rotation to determine the unit is phased correctly.

C. PROCESS FLOW ADJUSTMENT

1. The operator must determine and set proper fluid flow rate for the most efficient and trouble free operation.
 - a. Fluid flow rate through the process is determined by the pressure losses in the unit-to-process flow system. Generally, higher flow rates result in maximum temperature control and lower maintenance.
 - b. If the pressure loss is too low, the flow rate will be too high and the electric motor will draw excessive amps. This will eventually result in tripping the thermal motor overload relay (overload relays open) and the unit will shut down and illuminate the SAFETY and ALARM lights on the instrument display.
2. If a motor overload situation is encountered, the operator must manually reset the overload relay before operations can continue. This is done by opening the electrical panel cover, identifying the reset lever on the overload relay, and pushing the reset lever "in" until the overloads are reset (evidenced by a "clicking" sound as the overloads reset).
3. If a motor overload situation persists, the operator must adjust the flow rate to match the system pressure loss (reduce flow rate) to prevent continual tripping of the overall relay. The procedure to adjust process flow rate is outlined below:
 - a. Open electrical cabinet panel door. **Note that the electrical power is engaged at this point and caution must be observed while the cabinet panel is open.**
 - b. Identify the motor starter block (figure 3.2E). This block consists of the motor starter contactor and the overload relay.
 - c. Place an amp meter on a single power lead emanating from the overload relay.
 - d. Identify the electric pump motor. Locate the motor name plate on the motor housing.

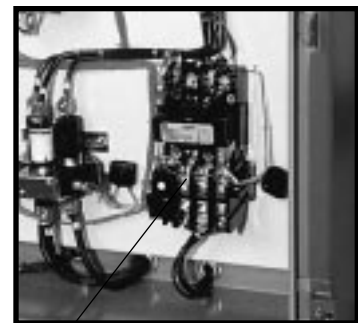

Motor starter block

Figure 3.2E

The full load amp rating for that motor is listed on the name plate.

- e. Engage the electrical power supply and start the electrical motor pump by toggling the UNIT ON/OFF rocker switch and then the PUMP ON rocker switch to the "on" position.

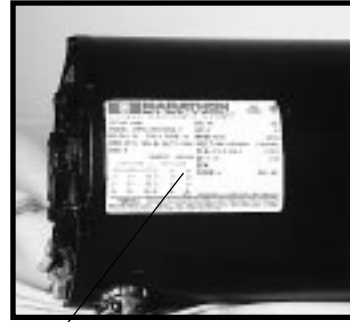

Motor data tag

Figure 3.2E

- f. The amp meter will display the motor amps. Compare the actual motor amps as displayed on the amp meter to the full load amp rating as listed on the motor name plate.
- g. If the amp draw is excessive (higher than the listed name plate amp rating), reduce flow by fully closing the from process valve. With the pump engaged, slowly open the valve and monitor the motor amps as displayed on the amp meter until the actual motor amps equals the listed full load amp rating of the motor. The process flow is now correctly adjusted. The valve should remain in the position during operations.

- 4. A low flow condition can cause the oil to degrade prematurely. If the process connections are not full line size the solids created by this premature degradation can plug mold passages, pump impellers, and build up on the heater elements causing heater failure. To prevent this condition, install a bypass (see diagram below) line between the process lines. The by-pass line should be as close to the mold as possible for best operation. The by-pass line should be 1/2 of the process line size with a shut-off valve to balance the flow.

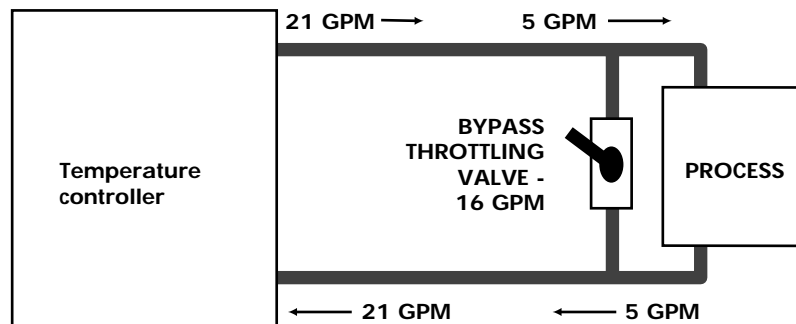

3.3 REGAL 1 LE INSTRUMENT OPERATION

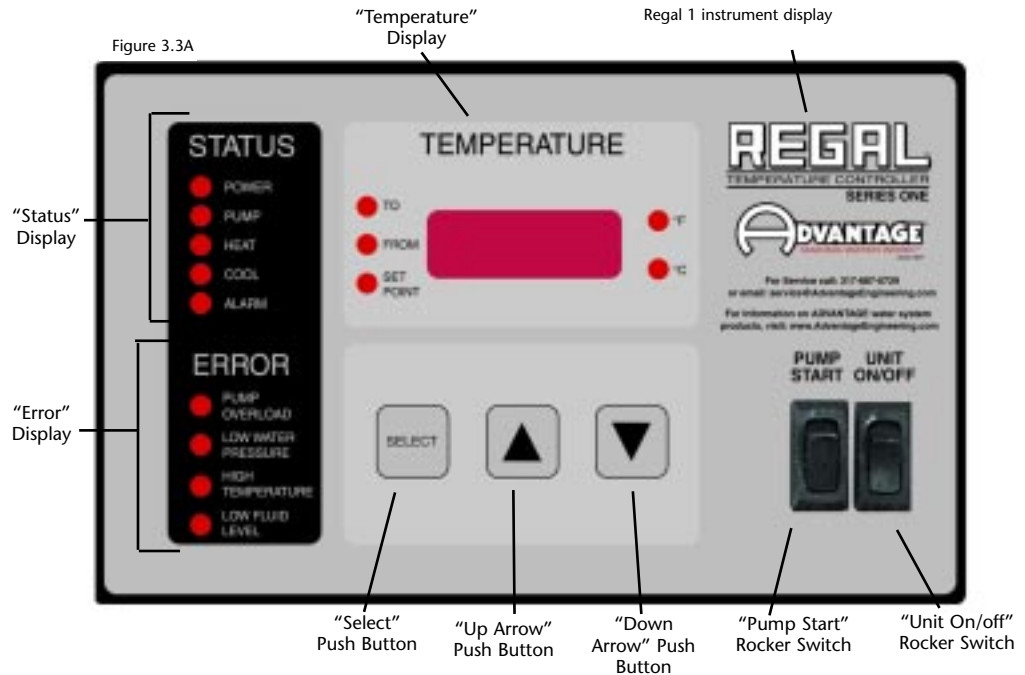

A. INSTRUMENT START-UP

1. When the correct electrical power and adequate water supply pressure are supplied to the unit, it is possible to start the unit for temperature control duty.
2. When the electrical power supply is engaged to the unit, the **Regal 1 LE** instrument will illuminate all indicating lights and digits on the display. After a short delay, the **Regal 1 LE** instrument will show the controller software version number in the display window. At this time, the operator can verify that all lights and digits are functioning properly. If an indicating light or digit is not functioning properly (does not illuminate), the instrument must be removed and sent to the factory for repair.
3. The **Regal 1 LE** instrument will immediately check the status of the high temperature safety switch and the water supply pressure switch for acceptable operating conditions. If all systems are found to be satisfactory, the unit can begin process temperature control operation. If a system is not found to be satisfactory, the **Regal 1 LE** instrument will prevent process temperature control operation and will illuminate the appropriate "error" light on the display. The operator must take action to correct the error situation.

B. REGAL 1 LE INSTRUMENT OPERATION

1. Process temperature control operation is started by toggling the UNIT ON/OFF rocker switch to the "on" position.
2. When the UNIT ON/OFF rocker switch is toggled "on", the **Regal 1 LE** instrument will immediately display the 'to process' temperature in the 'display' window. The 'to process' temperature is displayed continuously unless the 'from process' temperature is selected. If the display is left in the 'from process' display, the instrument will automatically revert back to the 'to process' display after 20 seconds of inactivity.
3. Depress the PUMP ON momentary rocker switch. If an unsafe condition exists, the pump will not start and a red 'error' indicator light will illuminate to signal a fault condition exists. If no faults are present, the pump will start.
4. Conditions that prevents the unit from starting process temperature control operations are:
 - a. **Water supply pressure inadequate** (pressure switch is open - LOW WATER PRESSURE light on). The unit is prevented from operating without adequate water supply pressure by a panel mounted pressure switch. Sufficient water supply pressure must be present to close the switch and consent the circuit to the electric motor starter.
 - b. **Motor overload relay opened** (PUMP OVERLOAD light on). The electric motor is protected from overload conditions (excessive flow) by a set of thermal overload relays. These relays will open (trip) and prevent electric power from reaching the electric motor. If the overload relay is open, the overload relay must be reset before operations can continue. An excessive flow condition must be corrected immediately.
 - c. **High temperature limit switch open** (HIGH TEMPERATURE light on). The unit is prevented from operations with temperatures exceeding 510°F by a 'high temperature limit switch'. This switch is installed in the heating cylinder. If this switch is open (due to a over-temperature condition), the control circuit is not consented and the unit cannot start. If a high temperature condition exists, the unit must first "cool down" (reduce fluid temperature) before the "high temperature limit switch" will automatically reset.

5. The operating setpoint temperature is programmed by depressing the SELECT push button until the SETPOINT light illuminates. The 'setpoint' temperature is displayed in the temperature window when the SETPOINT light is on. Then use the UP ARROW push button or DOWN ARROW push button until the preferred setpoint temperature is indicated in the display window. If left in the 'setpoint' selection mode, the instrument will display the setpoint temperature for 20 seconds, after which the instrument will revert to the 'to process' temperature display. Setpoint temperatures can be adjusted anytime. Once adjusted, the **Regal 1 LE** instrument will bring the system in line with the adjusted setpoint temperature.

C. REGAL 1 LE INSTRUMENT CONTROLS (figure 3.3B and 3.3C)

1. **UNIT ON/OFF SWITCH:** this rocker switch engages/disengages electrical supply to the pump and heater.
2. **PUMP START SWITCH:** if no fault conditions are present, depressing this momentary rocker switch starts the pump motor. If a fault condition is present, the pump will not start. Follow the troubleshooting section of this manual to isolate and resolve the fault condition.
3. **UP ARROW:** depress and hold this push button to increase the setpoint temperature. If this push button is pressed momentarily the setpoint value is incremented by one degree. If the push button is held down for more than one second, the setpoint will increase slowly at first and then faster after about two seconds. The setpoint control range is 100° to 500°F.
4. **DOWN ARROW:** depress and hold this push button to decrease the setpoint temperature. If this push button is pressed momentarily the setpoint value is incremented by one degree. If the push button is held down for more than one second, the setpoint will

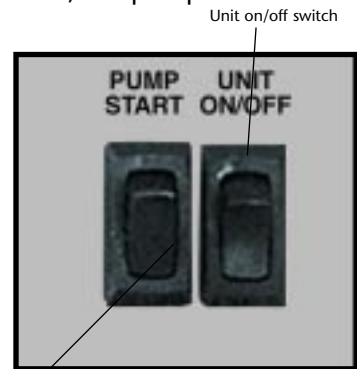

Pump start switch Figure 3.3B

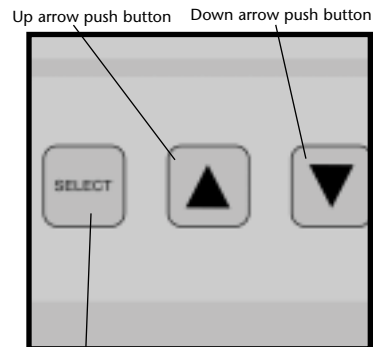

Up arrow push button Figure 3.3C

Select push button

increase slowly at first and then faster after about two seconds. The setpoint control range is 100° to 500°F.

5. **SELECT:** depress the SELECT push button to select between the 'to process', 'from process' or 'setpoint' temperature display.

D. REGAL 1 STATUS INDICATING LIGHTS (figure 3.3D)

1. **POWER ON:** illuminates when the proper supply of electrical power is applied to the unit.
2. **PUMP:** illuminates when the UNIT ON/OFF rocker switch is turned 'on' and the PUMP START rocker switch was depressed 'on'. Even with the this rocker switch 'on', the PUMP light will not illuminate if a safety fault condition exists.

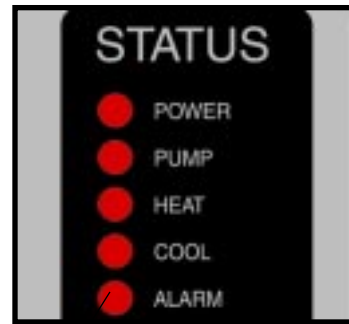

Status lights

Figure 3.3D

3. **HEAT:** illuminates when the **Regal 1 LE** instrument engages the heater contactor. Engaging the heater contactor supplies electrical current to the flange mounted heater in the heater/pump discharge tank. This action will increase process water temperature.
4. **COOL:** illuminates when the **Regal 1 LE** instrument opens the solenoid cooling valve. This allows cooling water from plant supply sources to circulate through the heat exchanger to cool the process fluid.
5. **ALARM:** if the 'to process' temperature deviates 5° or 10° (depending on the DIP switch selection) above or below the setpoint, the ALARM light will illuminate. A 110 volt output will be activated for an optional alarm buzzer or beacon. The deviation alarm is armed after the 'to process' temperature has achieved the desired setpoint and maintained it for 30 seconds

E. REGAL 1 TEMPERATURE DISPLAY INDICATING LIGHTS (figure 3.3E)

1. **TO:** illuminates when the 'to process' temperature has been selected for display.
2. **FROM:** illuminates when the 'from process' temperature has been selected for display.

3. **SETPOINT:**
illuminates when the 'setpoint' temperature has been selected for display.

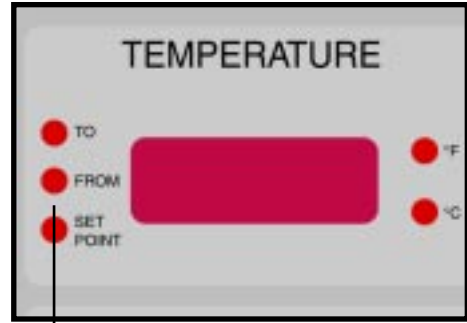

Status lights

Figure 3.3E

4. °F: illuminates when the appropriate DIP switch is set to '°F display'. The factory default setting is °F. The 'temperature display' will display all temperatures in the Fahrenheit temperature scale.
5. °C: illuminates when the appropriate DIP switch is set to '°C display'. The 'temperature display' will display all temperatures in the Celsius temperature scale.

F. REGAL 1 ERROR INDICATING LIGHTS (figure 3.3F)

1. **PUMP OVERLOAD:** the safety circuit is interlocked through the motor overload circuit. If the overload circuit opens, the pump motor will stop. When the PUMP START switch is depressed, the overload LED will illuminate. An overload condition may be caused by too much process flow. Check the current draw at the motor starter block. If excessive, reduce flow until proper current is reached. Defective motor windings may also be a caused of an overload condition. Check continuity across the motor windings to ground to determine if this is the case.



Error lights

Figure 3.3F

2. **LOW WATER PRESSURE:** the safety circuit is interlocked through the water pressure switch. This switch monitors the water supply pressure to the component cooling system including the pump seal cooling jacket and/or heat exchanger. A low water supply fault may be caused by a water supply source below 20 psi, water supply fluctuations which allow the water pressure to momentarily drop below 20 psi, a defective pressure switch, or a water supply valve not open.
3. **HIGH TEMPERATURE:** the safety circuit is interlocked through a high temperature limit switch. This switch is

located in each heater tank and monitors fluid temperature. If the fluid temperature exceeds 510°F, the unit is in a "run away heat condition" and the switch opens to stop the unit. A high temperature fault could be caused by: a defective electronic controller (in this case the controller could be out of calibration), the heater relay could be stuck in the closed position, the cooling solenoid could be defective.

4. **LOW FLUID LEVEL:** this light is not functional on **Regal 'RK'** models.

3.4 SHUT DOWN/DISCONNECT PROCEDURE

A. PRECAUTIONS/WARNINGS

1. The operator must precisely follow all shut down procedures outlined in this manual. If the operator fails to follow precisely all procedures outlined in this manual, an unsafe condition can develop resulting in damage to the unit or serious personal injury to operating personnel.
2. **WARNING:** when stopping unit operations and/or disconnecting the unit from the process system, the operator must determine the unit's process fluid temperature is below 100°F, all water system pressure is relieved and the unit's pressure gauge reads "0". Serious Injury to operating personnel and damage to the unit could result if a hot and pressurized unit is disconnected from the system.

B. UNIT SHUT DOWN (without system disconnect)

1. Adjust the setpoint temperature to 100°F or below. Setpoint temperature is indicated in the 'setpoint' window. The **REGAL 1 LE** instrument will disengage the heater contactor (if engaged) and open the solenoid cooling valve (if installed). Allow the unit to operate in this condition until process temperature as indicated on the "temperature" display is at the ambient temperature or below 200°F. Failure to cool the process fluid below 200°F may damage the pump shaft seal when the unit is shut down.
2. Stop unit operations by toggling the UNIT ON/OFF rocker switch to 'off'. This action disengages the unit's electric pump motor.
3. Disengage the water supply to the unit by closing the unit's water supply valve (if installed) or by turning off the water supply source at the central control point. Relieve all water supply pressure via the pressure relief valve.



4. Disengage the electrical supply to the unit by switching 'off' the fused disconnect. Determine the POWER light on the **Regal 1 LE** display is **OFF**.

C. UNIT SHUT DOWN (with system disconnect)

1. Adjust the setpoint temperature to 100°F or below. Setpoint temperature is indicated in the 'setpoint' window. The **REGAL 1 LE** instrument will disengage the heater contactor (if engaged) and open the solenoid cooling valve (if installed). Allow the unit to operate in this condition until process temperature as indicated on the "temperature" display is at the ambient temperature or below 200°F. Failure to cool the process fluid below 200°F may damage the pump shaft seal when the unit is shut down.
2. Stop unit operations by toggling the "unit on/off" rocker switch to "off". This action disengages the unit's electric pump motor.
3. Disengage the water supply to the unit by closing the unit's water supply valve (if installed) or by turning off the water supply source at the central control point. Relieve all water supply pressure via the pressure relief valve.
4. Disengage the electrical supply to the unit by switching "off" the fused disconnect. Determine the POWER light on the **Regal 1 LE** display is **OFF**.
5. Before disconnecting and removing the process circuitry, be certain all system pressure is vented and the pressure gauge reads "0". When the process circuitry is disconnected and removed from the unit, follow the **mold purge procedure** (section 3.5) to contain most of the process fluid in the unit if required. If draining process fluid from the system, discharge fluid into a suitable container and dispose according to the fluid's manufacturer's instructions. When the process circuitry is removed, a small amount of fluid will be discharged from the unit. Please note that this fluid should not be warm or pressurized if all shut down and disconnecting procedures were followed. Remaining process fluid can be discharged by removing the pump casing drain plug.



3.5 MOLD PURGE PROCEDURE

- A. The **REGAL 'RK'** temperature controller is equipped with a mold purge feature (figure 3.5A). This enables the operator to change molds without losing a substantial amount of process fluid.
- B. **Caution:** the expansion reservoir is sized to allow the purging of most process systems. Oversized, extra long process lines or oversized process fluid channels could cause an overflow of the expansion reservoir during the mold purge procedure.
- C. **Warning:** never attempt to purge hot fluid back to the unit. Damage to the unit and personal injury could result. Always cool the process fluid to below 100°F before beginning the mold purge procedure.
- D. To use the mold purge system:
1. Cool the process fluid to 100°F or below for safety.
 2. Turn off the unit and disconnect the power supply as outlined in this manual.
 3. Fully close the "to process" shut-off valve. Please note, the "from process" valve remains open at this time.
 4. Connect a compressed air line to the mold purge valve. The compressed air source must be regulated to a maximum of 10 psi. **Note: the air supply for mold purging must be completely dry!** Introduction of moisture to the oil supply may cause the unit to discharge oil and steam through the vent tube when reheated above 220°F.
 5. Slowly open the "mold purge" valve. The compressed air will push the process fluid back to the expansion tank in the unit.
 6. When the purge is complete as revealed by a completely filled sight glass, close the "mold purge" valve.
 7. Close the "from process" line shut-off valve.

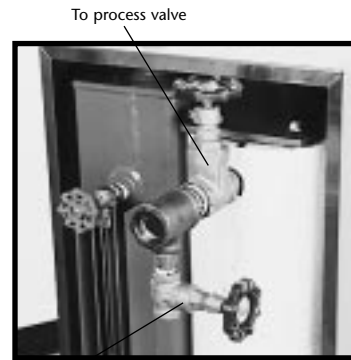

Figure 3.5A

4.0 TROUBLESHOOTING

- 4.1 UNIT WILL NOT START ("POWER" LIGHT OFF)
- 4.2 UNIT WILL NOT START ("POWER" LIGHT ON)
- 4.3 UNIT STOPS
- 4.4 UNIT OVERHEATS
- 4.5 UNIT UNDERHEATS



4.1 UNIT WILL NOT START ("POWER" LIGHT IS NOT ILLUMINATED)

- A. Power supply to the **Regal** unit is **OFF**. The operator should determine the POWER light on the **Regal 1 LE** display is "off". The operator should check for the follow conditions:
1. One or more fuses at the main disconnect device are open (blown). Determine continuity at each fuse. If continuity is not determined, replace the fuse.
 2. Control circuit transformer fuse open (blown). Determine continuity at the control circuit transformer fuse. If continuity is not determine, replace the fuse.

4.2 UNIT WILL NOT START ("POWER" LIGHT IS ILLUMINATED)

- A. **Power supply to the Regal unit is ON**. The operator should determine that electrical power supply to the **Regal** unit is "on" by an illuminated POWER light on the **Regal 1 LE** display. Even with the main power supply on, the **Regal** unit is prevented from operations by one of the following conditions:
1. **Water supply pressure inadequate** (pressure switch is open - LOW WATER PRESSURE light on). The unit is prevented from operation without adequate water supply pressure by a pressure switch. Sufficient water supply pressure must be present to close the switch and consent the circuit to the electric motor starter.
 2. **Motor overload switch opened** (PUMP OVERLOAD light on). The electric motor is protected from overload conditions (excessive flow) by a set of thermal overload relays. These relays will open (trip) and prevent electric power from reaching the electric motor. If the overload relay is open, overload relay must be reset before operation can continue. An excessive flow condition must be isolated and corrected immediately.
 3. **High temperature limit switch open** (HIGH TEMPERATURE light on). The unit is prevented from operations with temperatures exceeding 510°F by a 'high temperature limit switch'. This switch is installed in the heating cylinder. If this switch is open (due to a high temperature condition), the control circuit is not consented and the unit cannot be started. If a high temperature condition exists, the unit must first 'cool down' (reduce fluid temperature) before the 'high temperature limit switch' will reset.



4.3 UNIT STOPS

- A. The operator should determine the main power supply to the **Regal** unit is **ON** by an illuminated POWER light on the **Regal 1 LE** display head. With the main power supply 'on', the **Regal** unit will be prevented from operations by the following conditions:
1. **Water supply pressure inadequate** (pressure switch is open - LOW WATER PRESSURE light on). The unit is prevented from operation without adequate water supply pressure by a pressure switch. Sufficient water supply pressure must be present to close the switch and consent the circuit to the electric motor starter.
 2. **Motor overload switch opened** (PUMP OVERLOAD light on). The electric motor is protected from overload conditions (excessive flow) by a set of thermal overload relays. These relays will open (trip) and prevent electric power from reaching the electric motor. If the overload relay is open, overload relay must be reset before operation can continue. An excessive flow condition must be isolated and corrected immediately.
 3. **High temperature limit switch open** (HIGH TEMPERATURE light on). The unit is prevented from operations with temperatures exceeding 510°F by a 'high temperature limit switch'. This switch is installed in the heating cylinder. If this switch is open (due to a high temperature condition), the control circuit is not consented and the unit cannot be started. If a high temperature condition exists, the unit must first 'cool down' (reduce fluid temperature) before the 'high temperature limit switch' will reset.
- B. The operator should check the POWER light on the **Regal 1 LE** display. If the light is off, main electrical power to the **Regal** unit is not supplied. The operator should check the following conditions:
1. One or more fuses at the main disconnect device are open (blown). Determine continuity at each fuse. If continuity is not determined, replace the fuse.
 2. Control circuit transformer fuse open (blown). Determine continuity at the control circuit transformer fuse. If continuity is not determine, replace the fuse.

4.4 UNIT OVERHEATS

- A. The **Regal** unit will overheat when one of the following conditions are present. Overheating is evidenced by operations with 'to process' temperatures consistently above the selected setpoint temperature. Overheating is also evidenced by a 'to process' temperature that continues to escalate above the 'setpoint'



temperature with no apparent cooling action, even though the COOL light is on. Extreme overheating is evidenced by 'to process' temperatures over 510°F. The operator should check for the following conditions:

1. **Solenoid cooling valve defective (optional):** The **Regal 1** instrument opens (and closes) the cooling valve as prescribed by the current process load. If the solenoid valve becomes clogged with debris or scaled with mineral deposits, its operation is hindered (or fully prevented) and adequate cooling is prevented. The operator must service the cooling valve and remove any loose debris. Massive debris or scale deposits necessitate replacement of the cooling valve.

2. **Drain line obstruction:** The operator must determine if the drain line is obstructed by the following conditions. Section 2.4 outlines the parameters of correct drain line installation.
 - a. **Closed drain line valve.** An installed but partially or fully closed valve in the drain line prevents full discharge to drain and contributes to an overheating condition. The operator should determine the drain line is open.

 - b. **High drain back pressure.** Pressurized plant drain lines will prevent flow to drain if the differential between the water supply pressure and the drain line pressure is inadequate. The factory recommends a minimum differential of 10 psi. If the differential is less than the factory recommendation, plant service personnel should take measures to reduce drain line pressure.

3. **Low process flow rate:** The **Regal** unit works most efficiently when the flow rate is high. When conditions of low process flow rate develop due to obstructions in the process system, the heat input into the system is unable to "dissipate" normally and "collects" in the system. The operator should check that all valves are open and hoses (if used) are void of kinks. Obstructions could occur in the process tooling and the operator should take steps to fully open water channels in the tooling.

4. **Control sensor probe defective:** A defective control sensor probe "fools" the **Regal 1 LE** instrument that "to process" temperature is lower than the actual temperature. In such cases, the instrument will engage the heater to elevate process temperature resulting in an overheat condition. The operator must replace the defective probe with a probe in working order.



5. **Regal 1 LE instrument defective:** The **Regal 1 LE** instrument is designed and manufactured exclusively by **ADVANTAGE**. The instrument is life-tested and found to be field reliable. However, in the case where the instrument is determined to be defective, the operator must remove the assembly and return the assembly to the factory. The instrument is not a field serviceable component.

4.5 UNIT UNDERHEATS

- A. The **Regal** unit will underheat when one of the following conditions is present. Underheating is evidenced by operations with 'to process' temperatures consistently below the selected setpoint temperature.
 1. **Process water leakage.** When the **Regal 1 LE** instrument engages the heater to elevate process temperature, the input of heat into the process can be offset by the following:
 - a. **Defective cooling valve.** If the solenoid valve is defective, it may pass a larger than required stream to drain, thus providing unwanted cooling. A defective valve should be repaired immediately.
 2. **Heater element failure.** A failed heater element will not input adequate heat into the process to elevate temperature. The operator must check the amps at the heater contactor with the contactor energized. Zero amps indicates a failed heater. The operator should remove the failed heater and replace it with a new heater.
 3. The process may experience heat loss by:
 - a. **Radiation.** Radiation may be experienced when process lines are long and excessive.
 - b. **Unit capacity too low.** This occurs when the process requires more heat than the **Regal** unit's heater is capable of producing. In such cases the heat input is not sufficient to maintain setpoint temperature. The only option in such cases is to install a **Regal** unit with an adequate heater KW rating for the load.
 4. **Control sensor probe defective.** A defective control sensor probe "fools" the **Regal 1 LE** instrument that 'to process' temperature is higher than the actual temperature. In such cases, the instrument will disengage the heater and open the cooling valve to cool the process resulting in an underheat condition. To correct this condition, the operator must replace the defective probe with a probe in working order.



5. **Regal 1 LE instrument defective:** The **Regal 1 LE** instrument is designed and manufactured exclusively by **ADVANTAGE**. The instrument is life-tested and found to be field reliable. However, in the case where the instrument is determined to be defective, the operator must remove the assembly and return the assembly to the factory. The instrument is not a field serviceable component.



5.0 MAINTENANCE

- 5.1** PREVENTIVE MAINTENANCE
- 5.2** PUMP SEAL SERVICE
- 5.3** HEATING CYLINDER SERVICE
- 5.4** SOLENOID VALVE SERVICE
- 5.5** CONFIGURING TEMPERATURE DISPLAY UNITS
- 5.6** CONFIGURING ALARM TEMPERATURE PARAMETER



5.1 PREVENTIVE MAINTENANCE

- A. The following is a guide to preventive maintenance. The frequency of maintenance will vary with each application, installation conditions, flow rates, hours of use and operating temperatures.

- B. Preventive maintenance:
 - 1. Tighten all wiring connections.
 - 2. Check plumbing. Repair any leaks. The factory recommends using a high temperature graphite paste and teflon tape on all plumbing connections.
 - 3. Descale water cooling channels in the pump seal cooling adapter.
 - 4. Descale water cooling channels in the heat exchanger (if installed).
 - 5. Check process fluid for degradation. The operating conditions affects the useable life of the process fluid. Most heat transfer fluid manufacturers have an analysis program where a sample of process fluid can be sent to the manufacturer to determine when the fluid should be replaced. Some manufacturers even have reclamation programs of the spent fluid.
 - 6. Check sight glass for proper operation. Due to oil degradation, the sight glass feeder tubes may become clogged. In such cases, the sight glass may show an inaccurate level. Follow proper shut down procedures before removing sight glass to check feeder tubes.



5.2 PUMP SEAL REPLACEMENT

A. The **Regal** unit pump seal is a carbon/niresist shaft seal assembly including a stationary member, rotating member and tension spring (figure 5.2A).

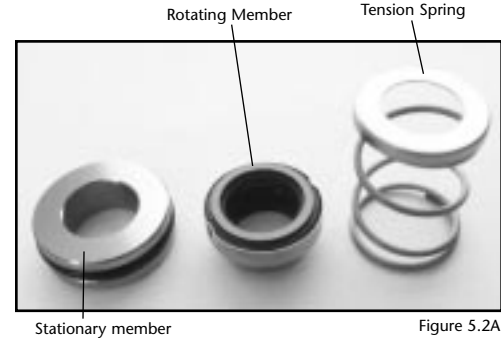

B. The operator can determine the pump seal is leaking when fluid is identified leaking from the pump case adapter.

C. Generally, a pump seal will leak due to inadequate unit pressure, excessive flow and poor fluid quality.

D. The operator should follow this procedure to replace the pump seal:

1. Disengage process operations according to the procedure outlined in **section 3.4**. The operator must be certain process fluid temperature is under 100°F and pressure is relieved (pressure gauge reads "0") and water system flow is shut off and all pressure relieved.
2. Disengage main power supply. The operator must verify the POWER light on the **Regal 1 LE** display is off.
3. Disengage the component cooling water supply to the unit by closing the unit's water supply valve (if installed) or by turning off the water supply source at the central control point. Relieve all water supply pressure by opening the pressure relief valve.

4. Access the pump motor by opening or removing any cover panels as necessary (figure 5.2B).

5. Drain machine. The machine can be drained by using the drain valve located on the pump case. Drain fluid into a suitable container for reuse or disposal according to manufacturer's instructions.

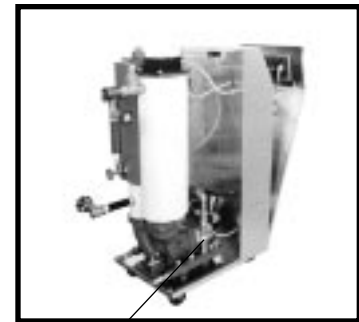

Lift-off panel removed.
RK-1230 shown

Figure 5.2B

6. Locate and remove the three motor wire leads from the motor wiring terminals. The operator should "map" the wire terminal locations to ensure correct rewiring. The power cord should be removed from the motor housing (figure 5.2C).

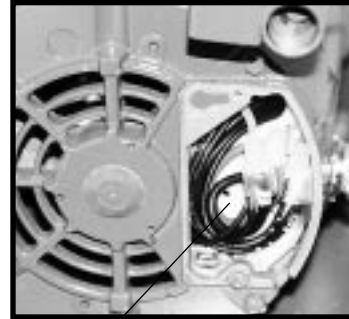

Motor wires exposed Figure 5.2C

7. Locate and disconnect the water lines from the pump adapter. These copper tubes supply cooling water to the pump seal cooling jacket (figure 5.2D).



Pump seal cooling line Figure 5.2D

8. Locate and remove the pump casing bolts. These bolts secure the motor and motor adapter to the pump casing (figure 5.2E).

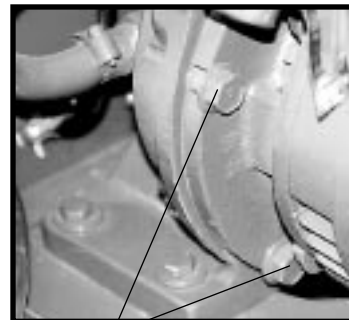

Pump casing bolts Figure 5.2E

9. Separate the motor and motor adapter from the pump casing to expose the pump impeller (figure 5.2F). Remove the motor and motor adapter from the **Regal** unit and place on a workbench to continue the procedure.

10. Locate and remove the dust cap from motor end to expose slotted motor shaft. The motor shaft is free to rotate, but must be secured to remove the impeller. To secure the motor shaft, insert a flat bladed screw driver in slot to hold the shaft stationary (Figure 5.2G).



Typical motor and casing separation Figure 5.2F

11. Locate and remove impeller locking screw (Figure 5.2H). Using a socket and ratchet, the impeller retaining screw can be removed. Once the

retaining screw is removed, the impeller can be "unthreaded" from the motor shaft to expose the pump seal assembly.

12. Remove all seal parts (Figure 5.2I). Note seal component arrangement to facilitate reassembly.
13. Clean motor shaft and lubricate with a mild soap solution.
14. Install new stationary seal member in pump casing cavity (figure 5.2J). The operator must be certain the stationary seal member is fully squared and seated in cavity.
15. Slide the rotating member onto the lubricated pump shaft (figure 5.2K). The operator must be certain not to damage or tear the rubber bellows assembly.
16. Place the spring onto the rotating member.
17. Align the impeller, spring and rotating member before reinstalling the impeller (figure 5.2L). The operator must be certain the spring and rotating member are aligned before the impeller is fully tighten and the impeller retaining screw is reinstalled.
18. Clean pump casing, cavities, impeller and O-ring before reassembly.
19. Mate the motor and motor adapter to the pump casing. Reinstall the pump casing bolts.



Motor shaft

Figure 5.2G

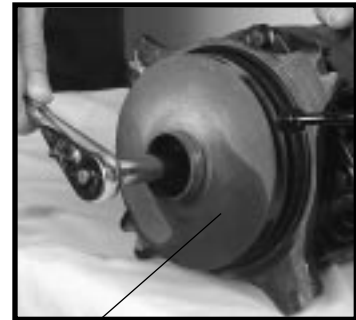

Impeller

Figure 5.2H

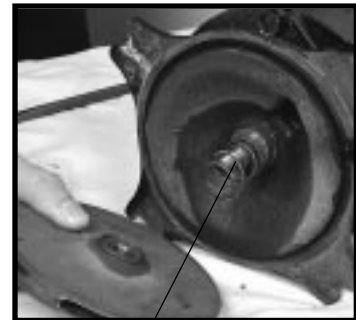

Seal components

Figure 5.2I

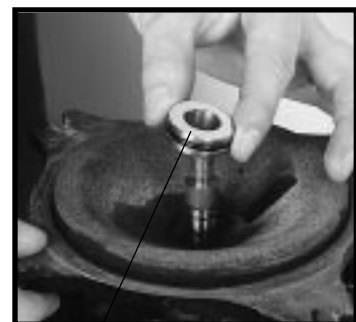

Stationary member

Figure 5.2J

- 20. Reconnect the water cooling lines to the pump adapter.
 - 21. Reconnect the motor power cord and leads.
 - 20. Restore all cover panels as were removed.
- E. When the pump seal replacement procedure is complete, the operator may restart the **Regal** unit according the **section 3**. In some cases, a new pump seal will experience a small amount of leakage for a short time. This is normal. After operating a few moments, the new seal will take action and the leak will stop.



Rotating member

Figure 5.2K



Seal members

Figure 5.2L

5.3 HEATING CYLINDER REPLACEMENT

A. The **Regal** unit's heater is a flange mounted assembly (figure 5.3A). The heater assembly is inserted into a cast tank and secured by mounting bolts.

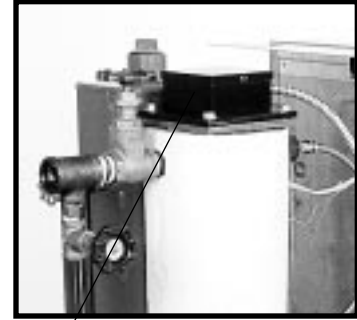

Heater

Figure 5.3A

B. The operator can determine the heater requires replacement when the heater draws "0" amps or when a continuity check of each heater element is negative.

C. Generally, heaters fail due to low fluid flow or contamination of the fluid.

D. The operator should follow this procedure to replace the heater:

1. Disengage process operations according to the procedure outlined in **section 3.4**. The operator must be certain process fluid temperature is under 100°F and pressure is relieved (pressure gauge reads "0").

2. Disengage main power supply. The operator must verify the POWER light on the **Regal 1 LE** display is "off".

3. Remove the lift-off access panel and set aside

4. Drain process fluid into a suitable container. The machine can be drained by opening the drain/fill valve.

5. Remove heater's junction box cover to located wiring connections. The operator should "map" the wiring connections to ensure correct reinstallation (figure 5.3B).



Heater Wires

Figure 5.3B

6. Disconnect the three power leads from heater terminals. Remove the power cord from junction box.

7. Remove the heater mounting bolts (figure 5.3C).



Heater bolts

Figure 5.3C

8. Remove heater (figure 5.3D).
9. Before the new heater is installed, the mating surface of the cast tank should be cleaned. Once cleaned, place the new heater gasket onto the mating surface. Coat the mating surfaces with a high temperature gasket sealant.

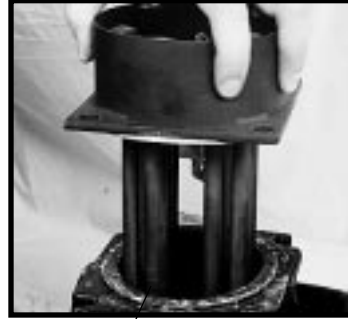

Heater removed

Figure 5.3D

10. Set new heater into tank. Aligning the bolt pattern of the heater and tank flanges.
 11. Replace the heater mounting bolts. Alternate to the opposite bolt while tightening.
 12. Reconnect the power cable to the heater terminals. Be certain to tighten the power cord junction box connector. Replace the junction box cover.
- D. When the heater replacement procedure is complete, the operator may restart the **Regal** unit according to the procedure outlined in **section 3** of this manual.

5.4 SOLENOID VALVE SERVICE

A. **Regal** units with the optional cooling system use a solenoid valve (figure 5.4A) to regulate flow through the heat exchanger. The solenoid valve is controlled by the **Regal 1** instrument.



Typical cooling solenoid valve on RK units

Figure 5.4A

B. The operator can determine the solenoid valve requires service when the process fluid is not cooled (unit overheats) as required.

C. Generally, cooling solenoid valves fail due to poor water quality, low water flow, or defective valve elements.

D. The operator should follow this procedure to service the cooling solenoid valve:

1. Disengage process operations according to the procedure outlined in **section 3.4**. The operator must be certain process fluid temperature is under 100°F and pressure is relieved (pressure gauge reads "0") and water system flow is shut off and all pressure relieved.
2. Disengage main power supply. The operator must verify the POWER light on the **Regal 1 LE** display is "off".
3. Remove or open any access cover panel and set aside to gain access to the cooling solenoid valve.
4. The operator must be certain all water system pressure is relieved. Use the pressure relief valve mounted in the drain manifold to relieve all pressure.

5. Identify the retaining screw (figure 5.4B) on the solenoid valve coil. Remove the screw. Keeping all electrical connections intact, lift the coil off of the enclosure tube and set aside.

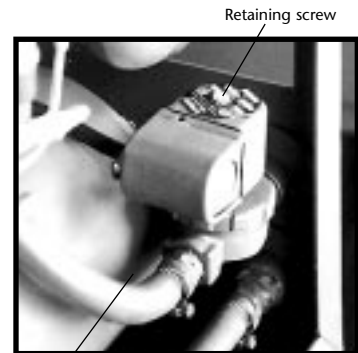

Coil

Figure 5.4B

6. Use a pair of channel lock pliers or a pipe wrench to separate the bonnet assembly from the valve body.

The plunger is "loose" inside the enclosing tube. Be certain it is retained in the enclosure tube as the bonnet is removed (figure 5.4C).

7. Identify the diaphragm assembly. Gently remove the assembly from the valve body (figure 5.4D).

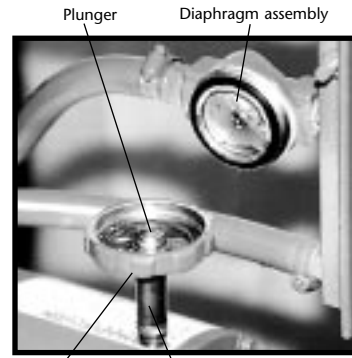

Top bonnet Enclosure tube Figure 5.4C

8. Identify the mesh screen. Gently removed the mesh screen and clean or replace as necessary. Clean the valve body.

9. Reset the mesh screen into the valve body.

10. If a new diaphragm assembly was obtained, continue with step 11. If not, disassemble the diaphragm assembly and note component order (figure 5.4E). Clean the valve port, plate, collar and O-ring. Once cleaned, reassemble the diaphragm.

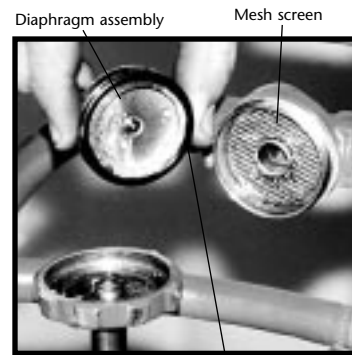

O-Ring Figure 5.4D

11. Set the reassembled diaphragm assembly into the valve body. The stem should be facing out of the valve body.

13. Inset the plunger with spring first into the enclosing tube of the top bonnet (figure 5.4F). Holding the plunger in the enclosure tube, set the top bonnet onto the valve body and tighten.

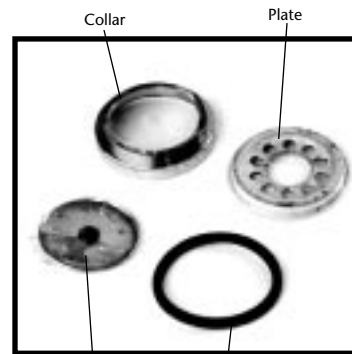

Figure 5.4E

14. Place the coil onto the top bonnet and replace the retaining screw.

15. Open the water supply and drain valves (if installed) to circulate water through the supply and drain manifolds. check the solenoid valve for leakage. Restart the unit.

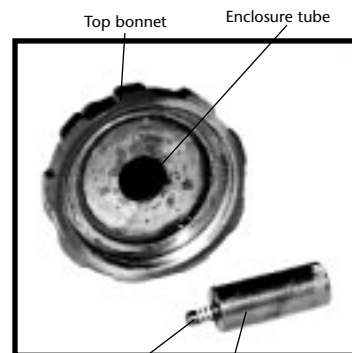
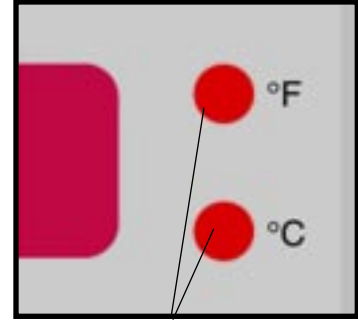

Figure 5.4F

5.5 CONFIGURING TEMPERATURE DISPLAY UNITS

- A. The operator may program the **Regal 1 LE** instrument to display temperature in either Fahrenheit or Celsius.
- B. Fahrenheit temperature display is indicated by the "°F" light. Celsius temperature display is indicated by the "°C" light (Figure 5.5A).
- C. The operator should follow this procedure for configuring the temperature display units:



Temperature unit indicating lights Figure 5.5A

1. Disengage process operations according to the procedure outlined in **section 3.4**. The operator must be certain process fluid temperature is under 100°F and pressure is relieved (pressure gauge reads "0").
2. Disengage main power supply. The operator must verify the POWER light on the **Regal 1 LE** display is "off".
3. Gain access to the **Regal 1 LE** instrument by opening or removing the necessary panel covers.
4. Locate the **Regal 1 LE** instrument chassis. The DIP switch is located on the "mother board" of the instrument assembly (figure 5.5B).
5. Locate switch #1. Use a small, non-conductive device and gently toggle the switch to the appropriate position for Fahrenheit display or Celsius display.
6. When the switch is set, close the electrical cabinet panel door.
7. Restart the unit according to the procedure outlined in **section 3** of this manual. The new selection takes effect immediately.

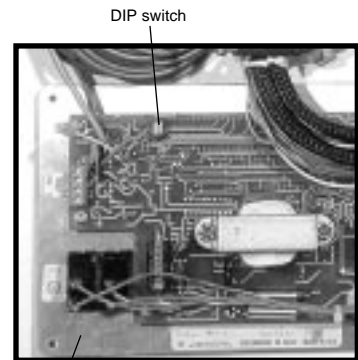

Regal 1 instrument Figure 5.5B

5.6 CONFIGURING ALARM TEMPERATURE PARAMETER

- A. The operator may program the **Regal 1 LE** instrument to signal an ALARM light if the "to process" temperature deviates over 5° or 10° from the 'setpoint' temperature. The factory alarm temperature parameter is set at 10°F.
- B. The **Regal 1 LE** instrument must bring process temperature to setpoint and then maintain setpoint temperature before the alarm temperature feature is armed. If the process temperature deviates from the setpoint temperature after the initial setpoint "lock", then the **Regal 1** instrument will signal the "alarm" light.
- C. The operator should follow this procedure to configuring the alarm temperature parameter:
1. Disengage process operations according to the procedure outlined in **section 3.4**. The operator must be certain process fluid temperature is under 100°F and pressure is relieved (pressure gauge reads "0").
 2. Disengage main power supply. The operator must verify the POWER light on the **Regal 1 LE** display is "off".
 3. Gain access to the **Regal 1** instrument by opening or removing the necessary panel covers.
 4. Locate the **Regal 1** instrument chassis. The DIP switch is located on the "mother board" of the instrument assembly.
 5. Locate switch #2. Use a small, non-conductive device and gently toggle the switch to the appropriate position 5° or 10° alarm.
 6. When the switch is set, close the electrical cabinet panel door. Restart the unit according to the procedure outlined in **section 3** of this manual. The new selection takes effect immediately.

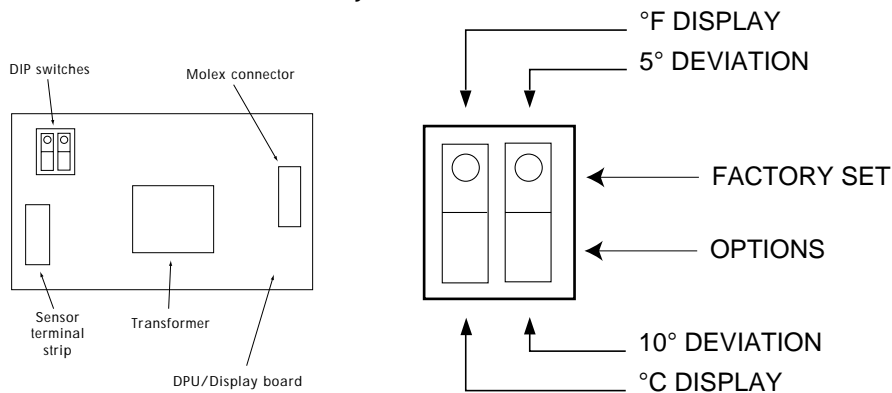

Schematic representation of the Regal 1 instrument and the DIP switch- reference section 5.5 and 5.6

6.0 REGAL COMPONENTS

- 6.1 MECHANICAL SYSTEM**
- 6.2 ELECTRICAL SYSTEM**



6.1 MECHANICAL SYSTEM

A. **PUMP/MOTOR ASSEMBLY:** The **Regal** unit pump is a multi-component assembly serving to circulate fluid through the process system. The pump will increase system pressure from 15 - 40 PSI over the at-rest pressure. The pump is driven by an electrical motor.

1. **Pump casing:** The pump casing is an exclusive **Regal** design. The casing is cast of iron and flanged to accept the heater/discharge and expansion tanks. The casing is the support element in the pump/motor assembly and is secured to the unit base (figure 6.1A).

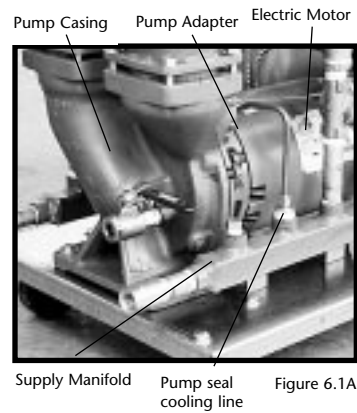

2. **Pump adapter:** the pump adapter is the mating element between the pump casing and the electric motor. Molded into the adapter is the pump seal cooling channel. The stationary pump seal member is set in the seal cavity of the pump adapter and is cooled by circulating water through the cooling channel from the supply manifold. (figure 6.1A).

3. **Electric motor:** the electric motor is a 3 phase, ODP motor. The motor serves to turn the pump impeller creating process flow (figure 6.1A).

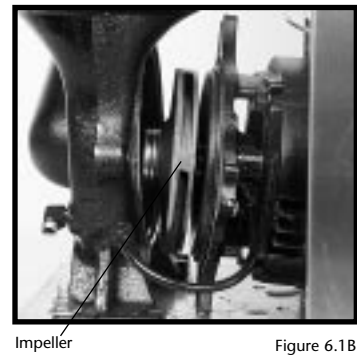

4. **Impeller:** the impeller is custom to the **Regal** unit and creates the process fluid flow (gpm) (figure 6.1B).

5. **Pump Seal:** the pump seal prevents fluid leakage from the pump adapter. The seal is made up of three items: the stationary member (seated in the seal cavity), the rotating member (placed on the motor shaft) and the tension spring (figure 6.1C shows the stationary member only).

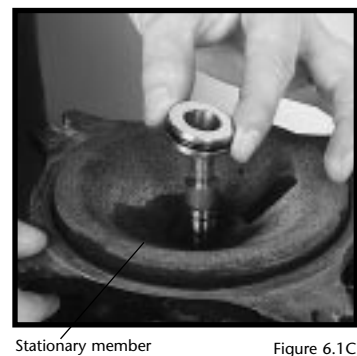

- B. **HEATER:** the heater is a flanged mounted immersion heater set in the pump discharge cylinder. The heater elements have a steel sheath. Electrical supply to the heater is provided via a mercury contactor (figure 6.1D).
- C. **HEATER/PUMP DISCHARGE CYLINDER:** the heater/pump discharge cylinder is a custom cast tank. The tank is heavily wrapped with layered fiberglass insulation, flanged mounted to the pump casing and the flanged mounted heater is placed inside the tank. The 'to process' connection and valve and mold purge valve assembly are mounted at the top of the tank. Thermocouple sensors, high temperature limit and oil feeder line to the heat exchanger (optional) are located at the top of the tank (figure 6.1E).
- D. **EXPANSION TANK/SUCTION CYLINDER:** the expansion tank is a custom welded tank designed to contain the expanding volume of heated process fluid. The tank is also designed to accept a majority of fluid volume for storage during mold purge. The suction cylinder is flanged mounted to the pump casing and accepts the "from process" valve and line (figure 6.1F).
- E. **SIGHT GLASS:** the fluid level sight glass gives an indication of the fluid level in the expansion tank (figure 6.1F).
- F. **FILL PORT:** the fill port accepts fluid for initial unit fill or "topping off" fluid level as required.
- G. **HEAT EXCHANGER:** the optional heat exchanger is of tube and shell design for high temperature use. The process fluid circulates through the "shell" side and cooling water from plant supplies circulates

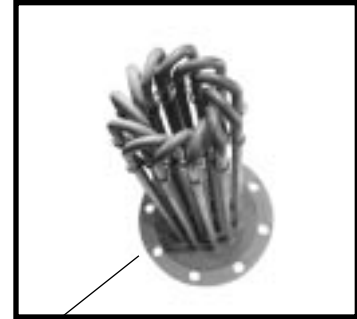

Typical Heater
High temperature limit switch
Oil feeder to heat exchanger

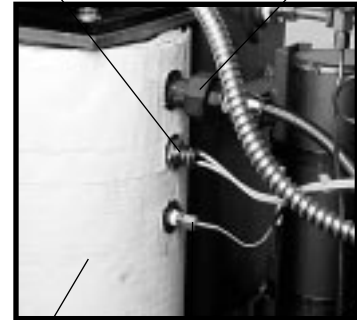

Insulation
Thermocouple
Figure 6.1E

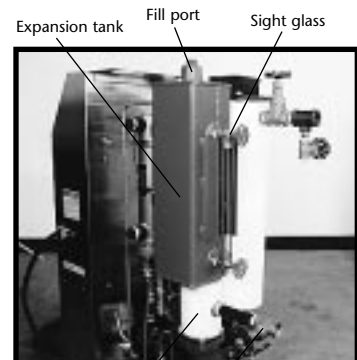

Expansion tank
Fill port
Sight glass
Suction Cylinder
From process valve
Figure 6.1F



Heat Exchanger
Figure 6.1G

through the "tube" side. Process fluid flow originates from the top of the heater/discharge tank, flows through the heat exchanger and returns to pump casing. Cooling water flow is controlled via the solenoid valve.

H. **WATER SUPPLY MANIFOLD:** the cooling water supply manifold serves to provide cooling water flow for pump seal cooling, optional heat exchanger cooling, and pressure switch (figure 6.1H).

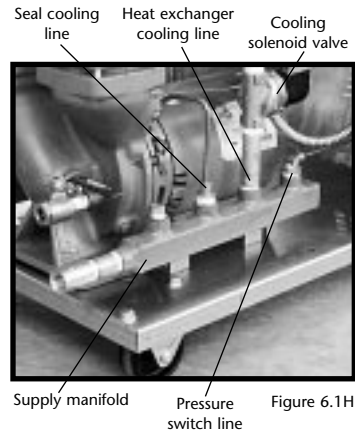

I. **DRAIN MANIFOLD:** the return manifold serves as a collection point for the optional heat exchanger and the pump seal cooling. The **PRESSURE RELIEF VALVE** is mounted in the return manifold on most models. The pressure relief valve is a 150 psi relief valve serving to discharge excessive unit pressure to the atmosphere. The valve can be manually activated by lifting the actuating lever (Figure 6.1I).

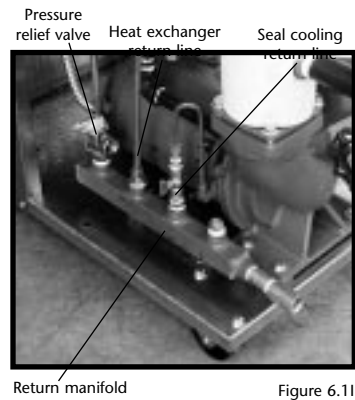

J. **PRESSURE GAUGE:** "to" process pressure gauge displays the system pressure, as generated by the process pump (figure 6.1J).

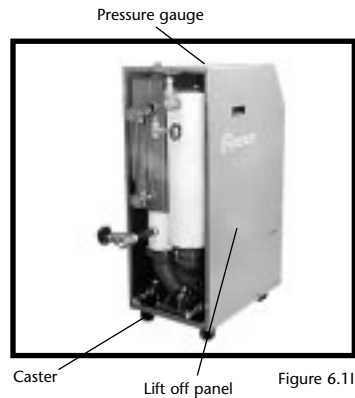

K. **CASTERS:** the Regal unit is mounted on 4 (2 swivel and 2 rigid) ball bearing casters. The casters allow the unit to be pushed to location (figure 6.1J).

L. **STAINLESS STEEL CABINETY.** The stainless steel cabinetry prevents unsightly rust and metal decay. The electrical cabinet cover is hinged and held open by support straps. The unit base is made of pressed steel with galvanized zinc coating. The lift off access panel is secured to the unit base by 4 thumb screws (figure 6.1J). The factory recommends using a dedicated "stainless steel" cleaning agent to clean the Regal cabinetry. Common household cleaners such as "Windex" will not maintain the mirror finish of the stainless steel (figure 6.1J).



6.2 ELECTRICAL SYSTEM

- A. **REGAL 1 LE INSTRUMENT:** the **Regal 1 LE** instrument is a custom designed and assembled microprocessor controller. The instrument is mounted to the electrical panel cover in most cases. The instrument controls the cycling of the heater, motor pump, cooling valve. System temperature is displayed continually. System parameters are programmable (figure 6.2A).



Regal 1 Instrument

Figure 6.2A

- B. **TRANSFORMER.** The transformer supplies 110 volts to the controlling instrument (Figure 6.2B).
- C. **MOTOR STARTER/OVERLOAD RELAY:** the electrical motor is engaged when the motor starter contacts close, on command by the **Regal 1 LE** instrument. The electric motor is protected from excessive amperage by a set of thermal overload relays, which open when excessive amperage "heats" up the overloads and the relay opens (figure 6.2B).

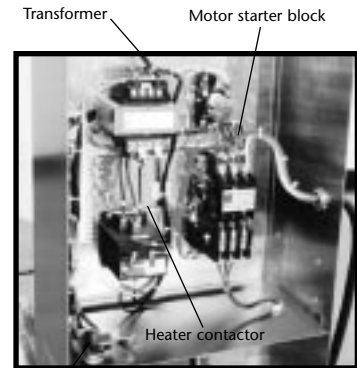

Pressure switch

Figure 6.2B

- D. **HEATER CONTACTOR.** The heater contactor is a mercury contactor. On command from the **Regal 1 LE** instrument, the mercury contactor will close and voltage will be supplied to the heater (figure 6.2B).
- E. **PRESSURE SWITCH.** The electric panel mounted pressure switch will close when sufficient pressure is supplied to the **Regal** unit (20 psi). A closed pressure switch will consent the control circuit to the **Regal 1 LE** instrument to allow process operations (figure 6.2B).
- F. **THERMOCOUPLE PROBE.** The **Regal 1** uses type-J thermocouple sensors. The "to process" sensor is mounted in the top of the heater/discharge tank. The "from process" sensor is mounted in the suction cylinder.
- G. **POWER CORD.** The supplied power cord (Nema 1 units only) is factory installed to the **Regal** unit. The power cord is a 3 conductor with 1 ground wire sized for the **Regal** unit and 10' in length.

THIS PAGE INTENTIONALLY BLANK

7.0 RELATED DRAWINGS

- 7.1 REGAL 'RK' PHYSICAL - 6-12 KW HEATERS & 1-3 HP PUMPS
- 7.2 REGAL 'RK' PHYSICAL - 36-48 KW HEATERS & 5-7.5 HP PUMPS
- 7.3 REGAL 'RK' MECHANICAL SCHEMATIC
- 7.4 REGAL 'RK' ELECTRICAL - REGAL 1 LE INSTRUMENT



7.1 REGAL 'RK' PHYSICAL - 6-12 KW HEATERS & 1-3 HP PUMPS

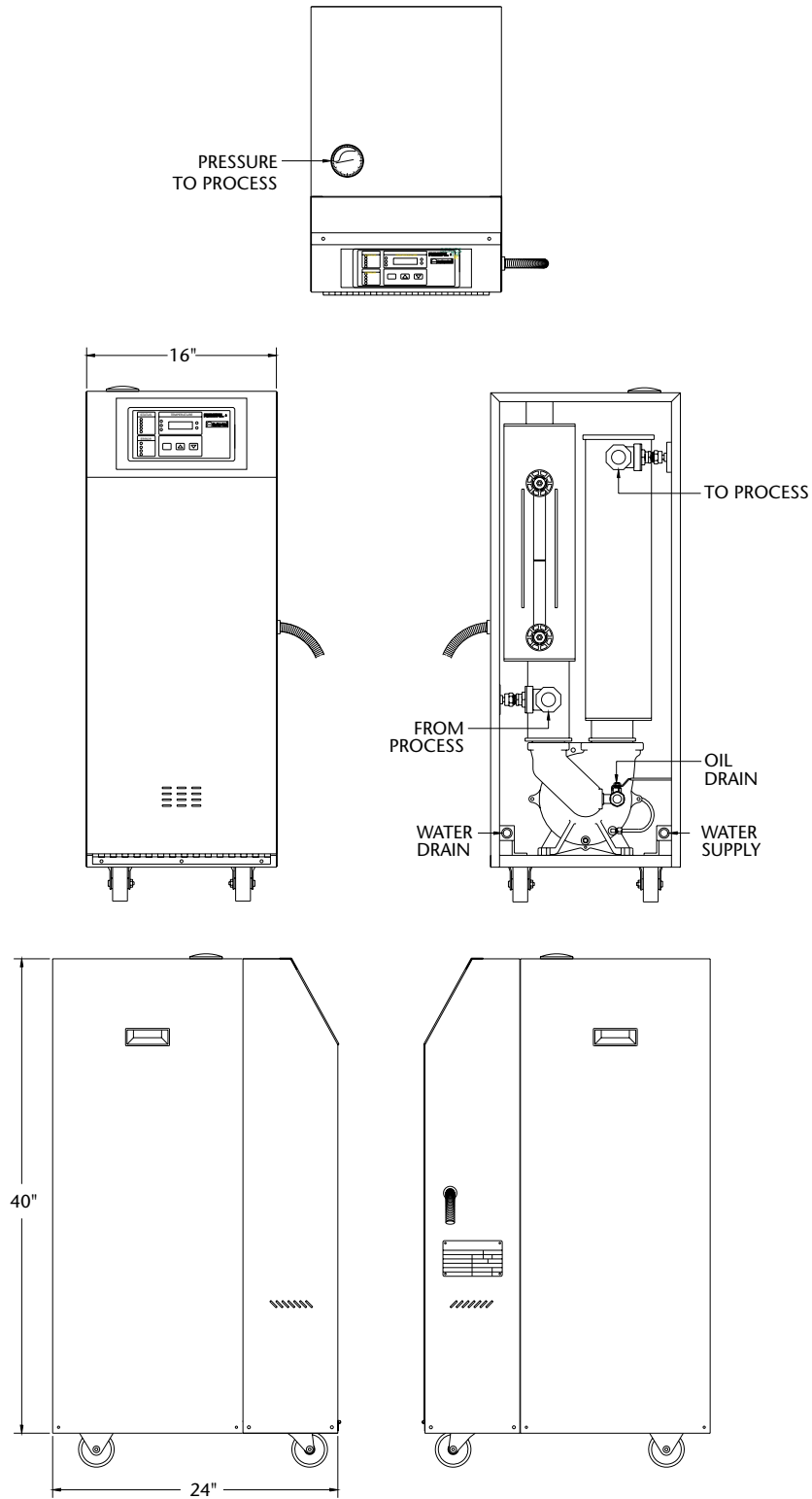

7.2 REGAL 'RK' PHYSICAL - 36-48 KW HEATERS & 5-7.5 HP PUMPS

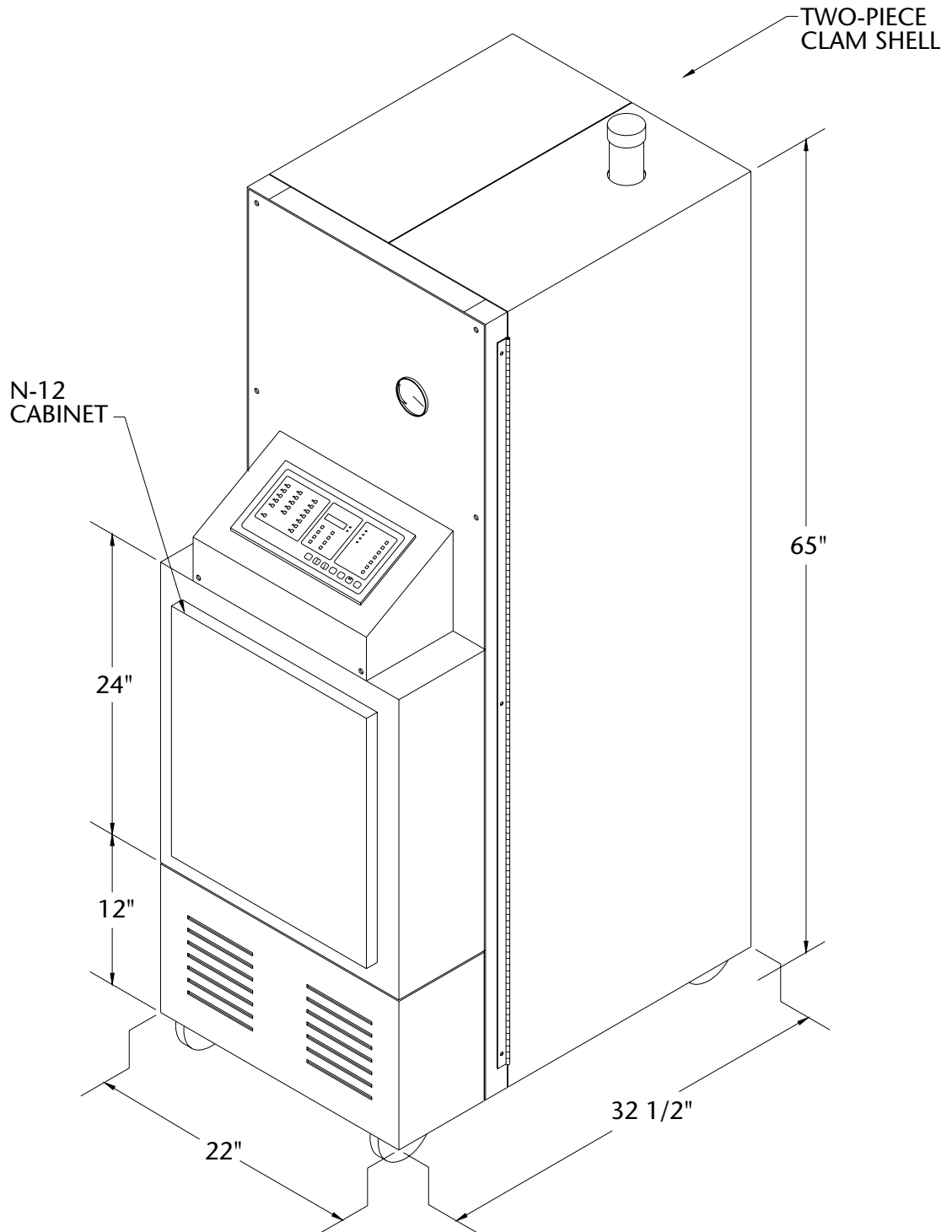

7.3 REGAL 'RK' MECHANICAL SCHEMATIC

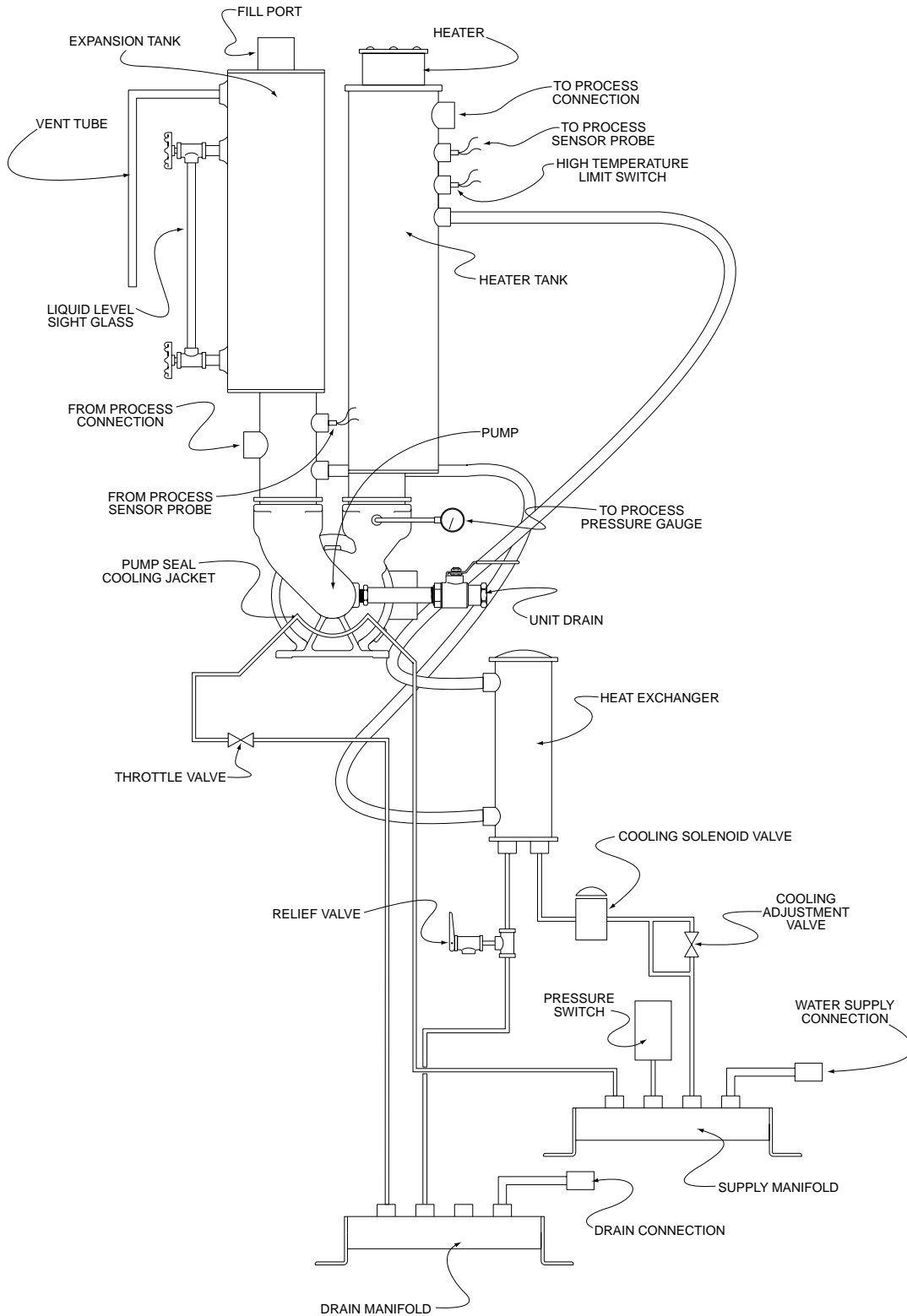

7.4 REGAL 'RK' ELECTRICAL - REGAL 1 LE INSTRUMENT

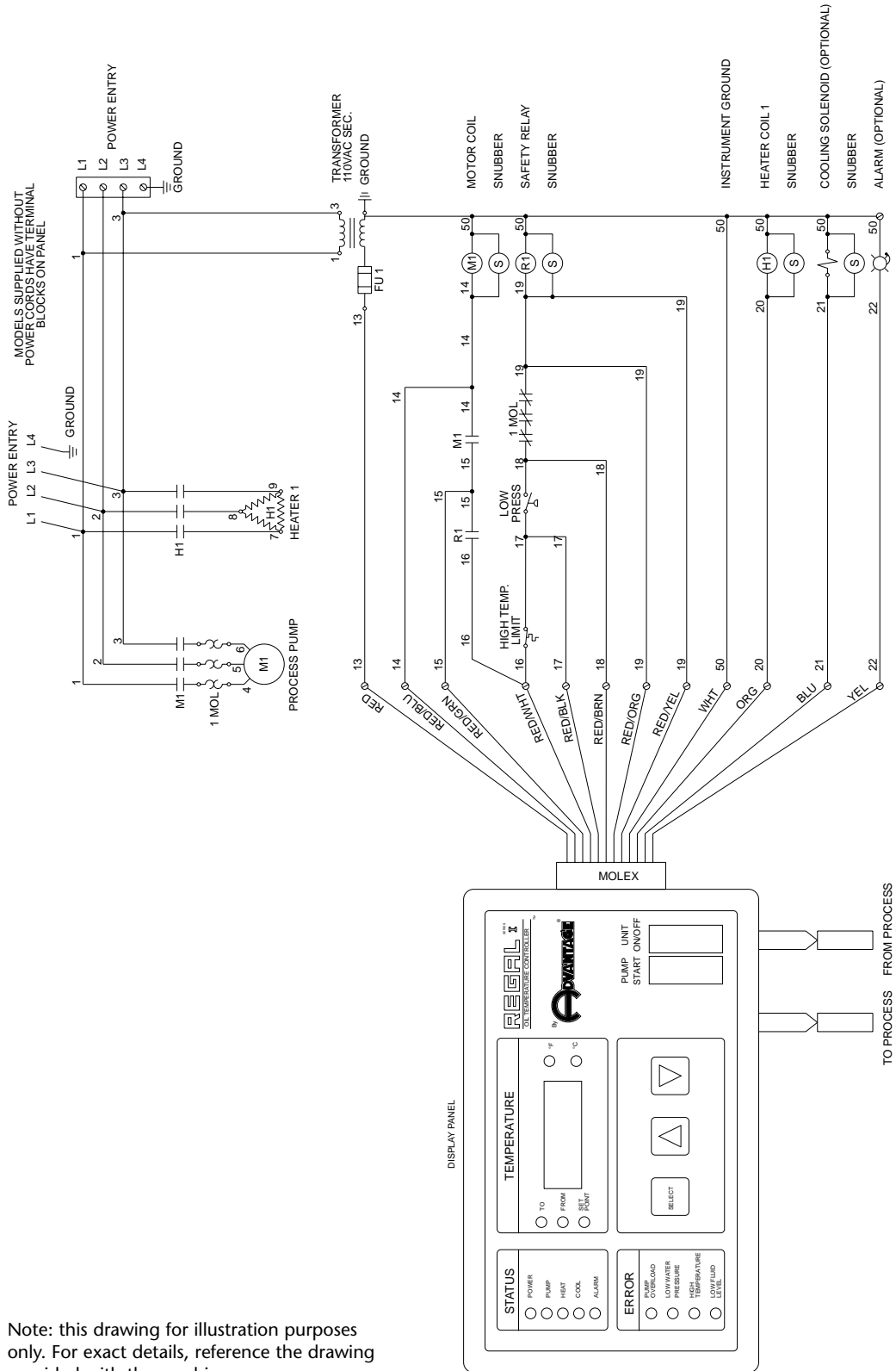

Note: this drawing for illustration purposes only. For exact details, reference the drawing provided with the machine.



THIS PAGE INTENTIONALLY BLANK

8.0 APPENDIX

- 8.1** REGAL 'RK' SPECIFICATIONS
- 8.2** REGAL 'RK' MODEL # AND SUFFIX CODING
- 8.3** WATER COOLED HOT OIL PUMPS
- 8.4** AMP RATING FOR THREE PHASE MOTORS
- 8.5** AMP RATING FOR SINGLE AND THREE PHASE HEATERS
- 8.6** SPECIFIC HEAT AND DENSITY FOR COMMON MATERIALS
- 8.7** USEFUL ENGINEERING FORMULAS
- 8.8** REGAL 'RK' SPARE PARTS LIST - 460 VOLT
- 8.9** REGAL 'RK' SPARE PARTS LIST - 230 VOLT
- 8.10** PARATHERM HEAT TRANSFER FLUID



8.1 REGAL 'RK' SPECIFICATIONS

MODEL	HTR KW	PUMP			AMPERAGE ¹		DIMENSIONS ²			PIPE SIZE		WGT ⁵
		HP	GPM	PSI	230	460	H	W	D	A ³	B ⁴	
RK-1230H	12	1	30	24	34.8	17.9	44	16	24	1	1/2	275
RK-1230HC	12	1	30	24	34.8	17.9	44	16	24	1	1/2	280
RK-1245H	12	1.5	45	26	36.4	18.7	44	16	24	1	1/2	285
RK-1245HC	12	1.5	45	26	36.4	18.7	44	16	24	1	1/2	290
RK-1250H	12	2	50	28	38.0	19.5	44	16	24	1	1/2	300
RK-1250HC	12	2	50	28	38.0	19.5	44	16	24	1	1/2	305
RK-1845H	18	1.5	45	26	40.8	26.2	55	20	28	1 1/2	1/2	580
RK-1845HC	18	1.5	45	26	40.8	26.2	55	20	28	1 1/2	1/2	585
RK-1850H	18	2	50	28	51.6	27.0	55	20	28	1 1/2	1/2	595
RK-1850HC	18	2	50	28	51.6	27.0	55	20	28	1 1/2	1/2	600
RK-1860H	18	3	60	26	56.0	28.4	55	20	28	1 1/2	1/2	610
RK-1860HC	18	3	60	26	56.0	28.4	55	20	28	1 1/2	1/2	615
RK-2760H	27	3	60	26	78.4	39.6	55	20	28	1 1/2	1/2	625
RK-2760HC	27	3	60	26	78.4	39.6	55	20	28	1 1/2	1/2	630
RK-2770H	27	5	70	28	84.0	42.4	65	22	33	2	1/2	715
RK-2770HC	27	5	70	28	84.0	42.4	65	22	33	2	1/2	720
RK-27100H	27	7.5	100	44	90.8	45.8	65	22	33	2	1/2	730
RK-27100HC	27	7.5	100	44	90.8	45.8	65	22	33	2	1/2	735
RK-3660H	36	3	60	26	101.1	50.9	65	22	33	2	1/2	640
RK-3660HC	36	3	60	26	101.1	50.9	65	22	33	2	1/2	695
RK-3670H	36	5	70	28	106.7	53.7	65	22	33	2	1/2	725
RK-3670HC	36	5	70	28	106.7	53.7	65	22	33	2	1/2	730
RK-36100H	36	7.5	100	44	113.5	57.1	65	22	33	2	1/2	740
RK-36100HC	36	7.5	100	44	113.5	57.1	65	22	33	2	1/2	745
RK-4870H	48	5	70	28	136.8	68.9	65	22	33	2	1/2	750
RK-4870HC	48	5	70	28	136.8	68.9	65	22	33	2	1/2	755
RK-48100H	48	7.5	100	44	143.6	72.3	65	22	33	2	1/2	770
RK-48100HC	48	7.5	100	44	143.6	72.3	65	22	33	2	1/2	775

1. Full load amps shown.

For 575 FLA: amps @ 460 x .81

For 208 FLA: amps = 230 x 1.11

2. Dimensions shown in "inches"

3. Process pipe size shown in "inches"

4. Water supply and drain pipe size shown in "inches"

5. Shipping weight shown in "pounds"



8.3 REGAL WATER COOLED PROCESS PUMPS

- A. The centrifugal pumps used on **ADVANTAGE** Regal RK series temperature controllers employ a water circuit to cool the mechanical seal.
- B. The exclusive **ADVANTAGE** hot oil pump has a "hidden" channel cavity molded into the casing. This channel circumscribes the seal area. The channel is fed cooling water from the plant's supply source. As the unit pumps hot oil (up to 500°F) to process, the cooling circuit serves to "protect" the seal by "spot" cooling the area immediately around the seal (see photograph below).
- C. As a safety precaution, a pressure switch is installed in the supply line to monitor the water source. If the pressure falls below 10 psi, the switch cuts the control circuit and the unit stops. Thus, the **ADVANTAGE** hot oil temperature controller can only operate when there is adequate cooling supply water.
- D. On Regal I microprocessor control instruments, a temperature sensor is installed into the channel to monitor the water temperature. If this temperature rises above 200°F, the microprocessor will signal a fault and shut down the unit as a safety precaution. Normally, this temperature is well below 150°F, even when the unit is heating oil to 500°F.
- E. The advantages to the **ADVANTAGE** water cooled hot oil pump are:
 - 1. Lower shaft seal temperatures for longer seal life (less maintenance!)
 - 2. Motor bearings run cooler for longer motor life (less maintenance!)

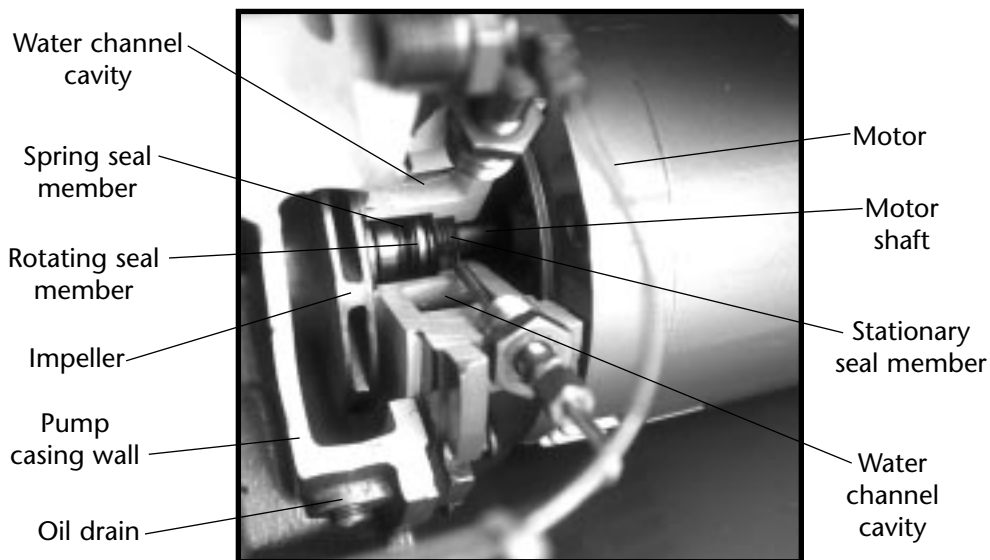

Pump casing has been "cut away" for this photograph

8.4 AMP RATING FOR THREE PHASE MOTORS

HP	208V	230V	460V	575V	HP
1/2	2.3	2.0	1.0	0.8	1/2
3/4	3.2	2.8	1.4	1.1	3/4
1	4.14	3.6	1.8	1.4	1
1 1/2	6.0	5.2	2.6	2.1	1 1/2
2	7.8	6.8	3.4	2.7	2
3	11.0	9.6	4.8	3.9	3
5	17.5	15.2	7.6	6.1	5
7 1/2	25.3	22.0	11.0	9.0	7.5
10	32.2	28.0	14.0	11.0	10
15	48.0	42.0	21.0	17.0	15
20	62.0	54.0	27.0	22.0	20
25	78.0	68.0	34.0	27.0	25
30	92.0	80.0	40.0	32.0	30
40	120.0	104.0	52.0	41.0	40
50		130.0	65.0	52.0	50
60			77.0	62.0	60
75			96.0	77.0	75
100			124.0	99.0	100



85 AMP RATINGS FOR SINGLE AND THREE PHASE HEATERS

TOTAL AMPERAGE - SINGLE PHASE

KW	VOLTS								
	110	115	120	208	230	240	440	460	480
1.0	9.1	8.7	8.33	4.8	4.4	4.2	2.3	2.2	2.1
2.0	18.2	17.4	16.7	9.6	8.7	8.33	4.6	4.4	4.2
3.0	27.3	26.1	25.0	14.4	13.0	12.5	6.8	6.5	6.3
4.0	36.4	34.8	33.3	19.2	17.4	16.7	9.1	8.7	8.33
5.0	45.5	43.5	41.7	24.0	21.7	20.8	11.4	10.9	10.4
6.0	54.6	52.2	50.0	28.9	26.1	25.0	13.6	13.0	12.5
7.0	63.6	60.9	58.3	33.7	30.4	29.2	15.9	15.2	14.6
7.5	68.2	65.2	62.5	36.1	32.6	31.3	17.1	16.3	15.6
10.0	90.9	87.0	83.3	48.1	43.5	41.7	22.7	21.7	20.8

TOTAL AMPERAGE - THREE PHASE

KW	VOLTS							
	208	230	240	440	460	480	550	600
1.0	2.78	2.5	2.4	1.3	1.3	1.2	1.1	1.0
2.0	5.6	5.1	4.8	2.6	2.5	2.4	2.1	1.9
3.0	8.34	7.5	7.2	3.9	3.8	3.6	3.2	2.9
4.0	11.1	10.1	9.6	5.3	5.0	4.8	4.2	3.9
5.0	13.9	12.6	12.0	6.6	6.3	6.0	5.3	4.8
6.0	16.7	15.1	14.5	7.9	7.5	7.2	6.3	5.8
7.0	19.5	17.6	16.9	9.2	8.8	8.4	7.4	6.7
7.5	20.8	18.9	18.1	9.9	9.4	9.0	7.9	7.2
8.0	22.2	20.1	19.3	10.5	10.1	9.6	8.4	7.7
10.0	27.8	25.1	24.1	13.1	12.6	12.0	10.5	9.6
12.0	33.4	30.2	28.9	15.8	15.1	14.5	12.6	11.6
15.0	41.7	37.7	36.1	19.7	18.9	18.1	15.8	14.5
18.0	50.0	45.2	43.4	23.7	22.6	21.7	18.9	17.3
24.0	66.7	60.3	57.8	31.5	30.2	28.9	25.2	23.1
30.0	83.4	75.4	72.3	39.4	37.7	36.1	31.5	28.9
36.0	100.0	90.5	86.7	47.3	46.0	43.4	37.8	34.7
42.0	116.7	105.6	101.2	55.2	52.8	50.6	44.1	40.5
48.0	133.4	120.6	115.6	63.1	60.3	57.8	50.5	46.2
60.0	166.7	150.8	144.5	78.8	75.4	72.3	63.2	57.8
75.0	208.4	188.5	180.6	98.5	94.2	90.3	78.8	72.3
100.0	277.9	251.3	240.6	131.4	125.7	120.4	105.1	96.3



8.6 SPECIFIC HEAT AND DENSITY FOR COMMON MATERIALS

MATERIAL	SPECIFIC HEAT	#/CUBIC FOOT
ETHYLENE GLYCOL / H ₂ O		
- 25/75	.92	
- 35/65	.86	
- 45/55	.79	
ALUMINUM	.24	159.7
IRON	.12	449.2
STEEL	.12	486.7
GLASS	.20	163.0
RUBBER	.45	58.0
PLASTIC, NOI	.65	
GRAPHITE	.20	130.0
PAPER	.45	58.8
WOOD (AVERAGE)	.52	45.0
ACETATE	.3 - .5	81.2
DELIN	.35	88.1
NYLON	.40	69.1
PHENOLIC	.40	79.5
POLYETHYLENE	.55	60.5
POLYSTYRENE	.32	65.7
TEFLON	.25	135.0
VINYL	.3 - .5	79.5
ISOCYANATE	.8 - .9	
POLYOL	.8 - .9	

8.7 USEFUL ENGINEERING FORMULAS

1 ton	=	12,000 btu
BTU	=	Material (lbs) X material 's specific heat X temperature difference
1 BTU	=	.293 watts
1 watt	=	3.42 BTU
1 KW	=	1000 watts
1 KW	=	3420 BTUs
BTU/hr	=	GPM X ΔT (for water cooled condensers)
TONS	=	$\frac{\text{GPM (water)} \times 8.34 \times 60 \times \text{temperature difference} \times \text{specific heat}}{12,000}$
TONS	=	$\frac{\text{GPM (water)} \times \Delta T}{12,000}$
1 Gallon of Water	=	8.34 lbs
	=	231 cubic inch
	=	.1337 cubic feet
	=	3.785 liters
	=	4 quarts
1 Pound of Water	=	.1198 gallon
1 Cubic foot of Water	=	7.481 gallons
	=	62.37 pounds
1 HP	=	2546.5 BTU/hr
	=	745.7 watts
	=	42.442 BTU/min
1 HP	=	$\frac{\text{PSI} \times \text{GPM}}{1199}$
1 HP	=	$\frac{\text{Feet of Head} \times \text{GPM} \times \text{Specific Gravity}}{2772}$
PSI	=	.4331 X Feet of Head
PSI	=	$\frac{\text{Feet of Head}}{2.3}$
1 Foot of Head	=	.4332 PSI
Feet of Head	=	PSI X 2.3
Watts	=	Amps X Volts (single phase)
	=	Amps X Volts X 1.73 (three phase)
Volts	=	Ohms X Amps
Volts	=	$\frac{\text{Watts}}{\text{Amps}}$
Volts	=	$\sqrt{\text{Watts} \times \text{Ohms}}$
1 KVA	=	$\frac{\text{Amps} \times \text{Volts} \times 1.73}{1000}$ (three phase)
1 KVA	=	$\frac{\text{Amps} \times \text{Volts}}{1000}$ (single phase)
CFM	=	$\frac{\text{KW} \times 300}{\text{Temperature Difference}}$
CFM	=	$\frac{\text{Tons} \times 10530}{\text{Temperature Difference}}$
KW	=	$\frac{\text{CFM} \times \text{Temperature Difference}}{3000}$
°F	=	(9/5 X °C) +32
°C	=	5/9 X (°F - 32)
Volume of Cylinder	=	$\pi \times R^2 \times L$
Circumference of Circle	=	Diameter of Circle X π
Diameter of Circle	=	Circumference X .3183
Area of Circle	=	$\pi \times R^2 \times L$
	=	D' X .7854
1 Gram	=	.0353 oz
1 Foot	=	30.48 centimeter
454 Gram	=	1 lb
1 Oz	=	28.35 grams
1 Kilogram-calorie	=	BTUH X .252
1 Millimeter	=	inches X 25.4
1 Kilogram	=	Lbs X .454
1 Square Centimeter	=	.155 square inch
1 Square Inch	=	6.452 square centimeter

METRIC CONVERSION TABLE

TO CONVERT			TO CONVERT		
FROM	TO	Multiply by:	FROM	TO	Multiply by:
UNIT VOLUME					
US GPM	liters/min	3.785	FT/LB/SEC	watts	1.356
US GPM	cum/hr	.2271	KW	BTUH	3420
CFM	liters/min	28.317	Boiler HP	BTUH	33475
CFM	cum/hr	1.6992	HP	BTUH	2545
UNIT WEIGHT					
Lbs/sq in	gr/sq cm	70.31	HP	kw	.7457
Lbs/sq in	kPA	6.894	HEAT		
Lbs/sq in	kg/sq cm	.07031	BTU	kg-cal	.252
Lbs/cu in	gr/cu cm	27.68	BTU/LB	kg-cal	.5556
LENGTH					
Inches	cm	2.540	BTU/SQ FT	gr-cal/sq cm	.2713
Feet	meters	.3048	BTU/CU FT	kg-cal/cum	8.899
Yards	meters	.9144	WEIGHT		
Miles	km	1.609	Grains	grams	.0648
VOLUME					
Cu inches	cu cm	16.387	Ounces*	grams	28.350
Cu inches	liters	.01639	Pounds*	kg	.4536
Cu feet	cu meters	.02832	US tons	lg	907.2
Cu feet	liters	28.317	US tons	tonnes	.9072
Cu years	cu meters	.7646	Long tons	kg	1016
Fl ounces	cu cm	29.57	AREA		
US gal	liters	3.785	Sq inches	sq cm	6.452
			Sq years	sq meters	.8361
			Sq miles	sq km	2.590

*Avoirdupois pounds and ounces

TEMPERATURE

°F	°C	°F	°C
0	-17.8	35	1.7
5	-15	40	4.4
10	-12.2	45	7.2
15	-9.4	50	10.0
20	-6.7	55	12.8
30	1.1	60	15.6

$$^{\circ}\text{F to } ^{\circ}\text{C} = (^{\circ}\text{F} - 32) \times .55 = ^{\circ}\text{C}$$

$$^{\circ}\text{C to } ^{\circ}\text{F} = (^{\circ}\text{C} \times 1.8) + 32 = ^{\circ}\text{F}$$

ABBREVIATIONS, EQUIVALENTS & FORMULAS

PSI = Pounds Per Square Inch	1 GALLON = 8.33 lbs (water)
GPM = Gallons Per Minute	1 CUBIC FOOT = 7.48 gallons
EWT = Entering Water Temperature	TOWER CELL EVAPORATION
LWT = Leaving Water Temperature	RATE = 2 gal. per ton per hour
BTU = British Thermal Unit	
BTU/HR = GPM x 500 x ΔT (water)	
FT. H.D. = PSI x 2.31	
1 COOLING TOWER TON = 15,000BTU/HR	
1 REFRIGERANT TON = 12,000 BTU/HR	



8.8 REGAL 'RK' SPARE PARTS LIST - 460 VOLT

PART #	DESCRIPTION
800000	Caster 3" Swivel
810000	Caster 3" Rigid
1835100	Contactactor 3035A120A 35 Amp
3570000	Pressure Gauge 0-60 PSI
3605000	Sight Glass Set 12"
3608600	Sight Glass Only 12"
3709750	Heat Exchanger 3.5 sq/ft
3804035	Heater 12KW oil 460 volt
4251030	Braided hose 3/8" NPT x 22"
4460161	Regal 1 Instrument kit #245500
6206499	Thermocouple Ungrounded Type J #6430030
6211032	Motor/pump assembly A5WF 1HP Oil Pump
415	Adapter AE5W #C2-4460 5 Hole Flange
771601	Case AE5 #D2-1728
3444175	Case Gasket A5W #A2-8611
4310488	Impeller A5W 4-1/2" #A2-8609X
4757863	Motor AE5/AS5/A5W 1HP #S-2773R
5486521	Impeller Nut AE5 #124S07A1
6495550	Shaft Seal A5W #S-2143
7163511	Slinger AE5 #C-8854
7250000	Solenoid Valve GP-4 1/2"
1162300	Solenoid Coil GP
6658000	Repair Kit GP-4
7303000	Plunger Spring GP-4
7370000	Motor Starter CR354ABAA1B
1733456	Auxiliary Contact Kit
7541000	Panel Mount Pressure Switch #MPL808-15 PSI-SPC
8156010	Thermostat High Temp Limit 520°F
8244000	Transformer 9T58B45
9060000	Relief Valve #150 PSI



8.9 REGAL 'RK' SPARE PARTS LIST - 230 VOLT

PART #	DESCRIPTION
800000	Caster 3" Swivel
810000	Caster 3" Rigid
1835100	Contactora 3035A120A 35 Amp
3570000	Pressure Gauge 0-60 PSI
3605000	Sight Glass Set 12"
3608600	Sight Glass Only 12"
3709750	Heat Exchanger 3.5 sq/ft
3804030	Heater 12KW oil 230 volt
4251030	Braided hose 3/8" NPT x 22"
4460161	Regal 1 Instrument kit #245500
6206499	Thermocouple Ungrounded Type J #6430030
6211032	Motor/pump assembly A5WF 1HP Oil Pump
415	Adapter AE5W #C2-4460 5 Hole Flange
771601	Case AE5 #D2-1728
3444175	Case Gasket A5W #A2-8611
4310488	Impeller A5W 4-1/2" #A2-8609X
4757863	Motor AE5/AS5/A5W 1HP #S-2773R
5486521	Impeller Nut AE5 #124S07A1
6495550	Shaft Seal A5W #S-2143
7163511	Slinger AE5 #C-8854
7250000	Solenoid Valve GP-4 1/2"
1162300	Solenoid Coil GP
6658000	Repair Kit GP-4
7303000	Plunger Spring GP-4
7370000	Motor Starter CR354ABAA1B
1733456	Auxiliary Contact Kit
7541000	Panel Mount Pressure Switch #MPL808-15 PSI-SPC
8156010	Thermostat High Temp Limit 520°F
8244000	Transformer 9T58B45
9060000	Relief Valve #150 PSI



8.10 PARATHERM NF SPECIFICATIONS

REPRINTED WITH PERMISSION OF PARATHERM

PARATHERM NF® SPECIFICATIONS	
PHYSICAL PROPERTIES	
Feedstock	NF/USP hydrotreated hydrocarbon base
Appearance	Transparent, colorless, bright
Taste & odor	None
Optimum use range	120°F to 600°F (49°C to 316°C)
Maximum recommended film temperature	640°F (338°C)
Flash point (coc) ASTM-D-92	345°F (174°C)
Flash point (pmcc) ASTM-D-93	335°F (168°C)
Fire point (coc) ASTM-D-92	385°F (196°C)
Autoignition ASTM-D-2155	690°F (366°C)
Autoignition ASTM-E659-78	691°F (367°C)
Atmospheric boiling point	
10% fraction, ASTM D-1160	650°F (343°C)
Vapor Pressure	
@ 200°F	0.0005
@ 300°F	0.003
@ 400°F	0.147
@ 500°F	0.967
@ 600°F	4.720
Coefficient of thermal expansion	0.000304/°F
Average molecular weight	350
Density, lb/gal @ 75°F (24°C)	7.25
Pour point (crystal point) ASTM D-97	-45°F (-43°C)
Pumpability: centrifugal @ 2,000 centipoise	-13°F (-25°F)
H ₂ solubility, @ 760 mm Hg/25°C	10 ppm by weight
Surface tension @ 760 mm Hg/25°C	28 dynes/cm
Heat of vaporization (calculated)	90.72 BTU/lb
ELECTRICAL PROPERTIES	
Dielectric strength @ 20°C	30-40KV/cm
DC volume resistivity	10 ¹² ohm
Dielectric constant @ 1 MHz	2.17
Dissipation factor @ 1 MHz	0.0002
OPTICAL PROPERTIES	
Refractive index @ 20°C	1.4768

ADVANTAGE Engineering recommends the use of **PARATHERM NF®** heat transfer fluid in hot oil temperature controllers. **PARATHERM NF®** can be purchased directly from the Paratherm Corporation (1-800-222-3611), a local vendor or **ADVANTAGE**. This document covers handling and use of **PARATHERM NF®**.

FLUID FOULING

Unlike conventional heat transfer fluids, **PARATHERM NF®** will not cause hard carbon formation on heated surfaces. Conventional heat transfer fluids, when severely overheated, can produce sooty carbon at the film layer. This carbon adheres to the heated surface

and bakes on forming a crust. As layer-upon-layer builds up, heat transfer-and in many cases, flows, are impaired. Nearly impossible to remove without scraping, sandblasting or using chlorinated solvents, carbon chunks can break off and circulate throughout the system impeding flows and fouling components. Where fouling is extreme, heater tubing and electrical elements can prematurely fail.

Under similar extreme overheat conditions, the **NF®** fluid evolves small carbon granules. These granules remain in suspension, and can be filtered out easily.

ENVIRONMENTAL SAFETY

The NF[®] fluid has passed the Bioassay test. Rainbow trout, Daphnia pulex and Mysidopsis bahia were subjected to a water-continued soluble fraction of the NF[®] fluid. No organisms died, and there were no ill effects. In the event of a spill, the NF[®] fluid can be treated using the same clean-up procedures employed for light lubricating oils. Once gathered and placed in a container, the NF[®] fluid can be sent to the local oil recycler, where it can be recycled into other usable materials. The NF[®] fluid contains no aromatics, heavy metals, or compounds of sulfur or nitrogen.

FLUID TOXICITY

PARATHERM NF[®] is completely non-toxic. It is certified by the FDA and USDA for use with food and pharmaceuticals, and carries the USDA's H-1 incidental food contact rating. Where other fluids can produce skin dermatitis, the NF[®] fluid has been reported to actually soften the skin. If the fluid is ingested in any quantity, laxative properties may be observed.

VAPOR PRESSURE

PARATHERM NF[®] fluid has a vapor pressure well below atmosphere at its maximum operating temperature of 600°F. Combined with a low pressure drop, low vapor pressures permit the designer more latitude in the choice of lower-cost equipment (at 600°F vapor pressure of the NF[®] fluid is just 4.72 psia).

EFFICIENCY

The lower a heat transfer fluid's viscosity, the lower the energy required to pump it through the system. **PARATHERM NF[®]** has among the lowest viscosity of any high temperature heat transfer fluid available. This means that less horsepower is needed for a given duty and that a smaller pump and motor can be specified.

CORROSION IN THE SYSTEM

The NF[®] fluid is manufactured from natural oil feedstocks, and offers similar metal-coating and lubricating properties as natural oils. However, any water allowed to stand in thermal oil systems can cause severe corrosion. Because the NF[®] fluid is slightly less dense than, and will not mix with water, water in the system can be easily drained from the system's low points. Open a low point and allow fluid to drain into a beaker. If you see a phase separation, continue to drain until no separation is observed.

STORING

Drums of heat transfer fluid should be kept in non-hazardous dry areas. Until ready for use, the seals

should not be broken. Liquids should not be allowed to pool on the tops of the drums. In the afternoon and evening when temperatures cool, the heat transfer fluid will contact this "pooling" liquid. A partial vacuum is created in the drum, and if the bung seal is not perfect, any liquid on the top can be drawn through contaminating the fluid.

FLUID DISPOSAL

Because **PARATHERM[®]** heat transfer fluids are produced from natural feedstocks, they are exceptionally safe to use and easy to dispose. The fluids can be safely combined with used lubricating oils and recycled or burned for BTU value. **PARATHERM[®]** strongly encourages recycling of used heat transfer fluid to conserve our precious natural resources and to minimize the problem of liquid waste in landfills. We suggest you check local, state and federal regulations first. **Note:** liquids contaminated with chlorinated solvents or other regulated materials may require special handling, and may not be accepted by recyclers.

FLUID ANALYSIS

Overheating, oxidation and contamination of your heat transfer fluid will cause a reduction in its ability to perform. In severe cases, damage to the thermal oil system can result. Periodic analysis of your fluid can allow you to detect problems in the early stages, and can result in substantial savings. Once your system is charged with **PARATHERM[®]** heat transfer fluid, **PARATHERM[®]** offers the first analysis at no charge to encourage a regular program of testing.

QUALITY CONTROL

PARATHERM[®] tests each batch of heat transfer fluid to ensure that product specifications are being met. Each shipment is traceable to the master batch, with test results held at **PARATHERM[®]**.

TECHNICAL ASSISTANCE

PARATHERM[®]'s technical expertise is available to you during the planning and design stages, and through system construction, start-up and operation. **PARATHERM[®]** will be pleased to work closely with you in the recommendation of proven systems, components and procedures. We can also advise you on system cleaning and repair. should these become necessary.

FOR MORE INFORMATION CONTACT:



Paratherm Corporation

1050 Colwell Road • Conshohocken PA 19428
(610) 941-4900 • Fax (610) 941-9191 • (800) 222-3611

END

© 2002 ADVANTAGE ENGINEERING, INC.

RE 2 8/02

